

Chandler Heights

Community Wildfire Protection Plan



Prepared by Forest Stewardship Concepts, Ltd. at the request of Chandler Heights Homeowners Association and Fremont County, Colorado.

Signatory Page

The following people have reviewed and approved the Chandler Heights Community Wildfire Protection Plan. It is now ready for implementation.

President, Board of Directors,
Chandler Heights Homeowners Association

Date

Gene MacKinnon, Chief, Florence Fire Protection District

Date

Jim Beicker, Sheriff, Fremont County

Date

Chair, Fremont County BOCC

Date

Steve Morrissey, Director, Fremont County
Office of Emergency Management

Date

John Grieve, State District Forester,
Cañon City, Colorado State Forest Service

Date

TABLE of CONTENTS

SIGNATORY PAGE	2
RECORD OF CHANGES:.....	3
TABLE OF CONTENTS	4
PREFACE:.....	7
I. COMMUNITY IDENTIFICATION & DESCRIPTION	8
II. FIRE ADAPTED COMMUNITIES	9
III. CHANDLER HEIGHTS COMMUNITY ASSESSMENT	12
Colorado Wildfire Risk Assessment (WRA) Summary Report.....	12
Fire Behavior.....	13
Characteristic Rate of Spread	14
Characteristic Flame Length	16
Fire Intensity Scale	17
Fire Type	18
Surface Fuels.....	20
Fuel Hazards	22
Risk of Ignition and Wildfire Occurrence.....	23
IV SITE SPECIFIC WILDFIRE HAZARD & RISK ASSESSMENT.....	24
Values:	24
Access:	24
Risk:	25
Triage:.....	25
Evacuation:	27
Local Preparedness and Protection Capability	27
Water Supply:	28
Wildfire Hazard & Risk Assessment Score sheet.....	31

V. COMMUNITY MITIGATION PLAN	33
HOW BUILDINGS ARE IGNITED BY WILDFIRE	33
Home Ignition Zone	33
Survivable Space:	34
State Tax Incentives for Wildfire Hazard Mitigation:.....	36
Education and Information:.....	36
Fuel Hazard Reduction:.....	37
Slash Disposal:.....	37
Wildfire Suppression Infrastructure:	38
Water Supply:	38
Turnarounds:	38
Fire Control Features/Triage Maps:	38
Evacuation Planning:	38
Evacuation Options:.....	39
V. IMPLEMENTATION & MONITORING.....	40
Implementation:	40
Table 8: Recommended Items Priority & Cost.....	40
Monitoring:.....	40

Appendices:

A - General Maps (*Large scale maps are available at Fremont County Office of Emergency Management.*)

B – Triage and Fire Control Features Map

C – Evacuation Planning

D – Structure Triage

E – FireWise

F – Fuelbreak Guidelines

G – Recommended Shaded Fuelbreaks

H – Road & Driveway Specifications

I– Definition of Terms

J– Potential Sources of Funding

K- References & Publications

L- Colorado Wildfire Risk Assessment Summary Report

M- Protecting Your Home from Wildfire - Creating Wildfire Defensible Space Zones

N - **Alert Fremont** Emergency Notification

O - Chandler Heights CWPP Triage Notes

PREFACE:

A Community Wildfire Protection Plan (CWPP) is a local wildfire protection plan that can take a variety of forms based on the needs of the community. The CWPP may address issues such as wildfire response, hazard mitigation, community preparedness, training, equipment or structure protection – or all of the above.

The process of developing a CWPP can help a community clarify and refine its priorities for protection of life, property and critical infrastructure in the wildland-urban interface. It also can lead community members through valuable discussions regarding management options and implications for the surrounding watershed.

This CWPP incorporates the “Fire Adapted Communities Concept” by including projects that support resilient landscapes and addressing the community response to wildfires.

CWPPs also improve a community’s ability to compete for grants to fund hazard mitigation projects, prevention, and preparedness education for residents in the community.

The wildland urban interface (WUI) is another term found throughout this document. It can be simply described as the geographical area where structures and other human development meet or intermingle with wildland or vegetative fuels.

For the purposes of community wildfire protection planning a more specific definition is used. The Healthy Forest Restoration Act defines wildland-urban interface as:

- a.) an area extending ½ mile from the boundary of an at risk community.
- b.) an area within 1.5 miles of the boundary of an at-risk community, including any land that:
 1. Has a sustained, steep slope that creates the potential for wildfire behavior endangering the at risk community.
 2. Has a geographic feature that aids in creating an effective fire break, such as a road or ridge top.
- c.) An area that is adjacent to an evacuation route for an at risk community that requires hazardous fuels reduction to provide safer evacuation from the at risk community.

I. COMMUNITY IDENTIFICATION & DESCRIPTION

The Chandler Heights (CH) area is in Fremont County, West of Williamsburg Colorado. It covers approximately 1,349 acres, with roughly 640 acres being Chandler Heights Home Owners Association (CHHOA). Elevation ranges from 5,563 feet near the southern boundary to 5,847 feet in the northeast corner of the analysis area. County Road 79, Chandler Heights road, provides access to the subdivision and Auckland Avenue continues inside the development. See **Figure 1: Chandler Heights Vicinity Map** for an understanding of the CWPP location. See **Table 1: Chandler Heights Land Ownership** to get an idea of land ownership distribution.

CH area contains 24 total lots within its boundary. Of the 24 parcels 18 or (75%) are considered improved and 6 or (25%) unimproved. 18 of the 24 lots are included in the HOA. Auckland Avenue runs 2.36 miles along the crest of the mesa. It is a reasonably good dirt and gravel road that provides year round access.

Chandler Heights Homeowners Association is active within the CWPP boundary. Defensible space activities are evident on a few of the properties.

Large wildfires are not unusual in the area. The Dinosaur fire burned 2,400 acres in 1988 on the north eastern side of Cañon City. The Royal Gorge fire of 2013 burned 3,218 acres and destroyed forty eight structures in similar fuel types and terrain as found in Chandler Heights. The Parkdale fire of 2010 burned 629 acres and destroyed five structures. These fires increased Chandler Heights resident's awareness of the hazards of living in a wildland setting.

Initial attack for all wildland and structure fires on Chandler Heights is provided by the Florence Fire Protection District (FFPD), Fremont County Wildland Fire Team, Colorado State Department of Public Safety, Bureau of Land Management and US Forest Service.

Table 1: Chandler Heights CWPP Land Ownership

Name	Acres
Chandler Heights HOA	640
Other Private	706
Total	1,349

II. Fire Adapted Communities

Communities in wildfire prone areas are learning what it takes to be fully prepared for wild land fire. A fire adapted community incorporates people, buildings, businesses, infrastructure, cultural resources, and natural areas into an effort to prepare for the effects of wild land fire. Community leaders and residents accept responsibility for living in an area with wildfire hazards. They have the knowledge and skills and have adopted tools and behaviors to prepare in advance for their community's resilience in a wildfire prone environment.

A Fire Adapted Community..... *(Source: Guide to Fire adapted Communities)*

- ✓ Acknowledges and understands its wildfire risk
- ✓ Recognizes that it is in or near a fire prone ecosystem
- ✓ Has leaders and citizens with knowledge, skills, willingness and realistic expectations to properly prepare for and deal with wildland fire
- ✓ Communicates clearly with citizens about wildfire risks and specific methods for preparedness
- ✓ Has adequate local fire suppression training, equipment, and capacity to meet realistic community protections needs
- ✓ Creates and uses a Community Wildfire Protection Plan (CWPP)
- ✓ Reduces levels of flammable vegetation on lands near and inside the community
- ✓ Has local building, planning, zoning and fire prevention policies and codes that require ignition resistant buildings, building materials, and landscapes
- ✓ Has buildings and landscapes that are designed, constructed, retrofitted, and maintained in a manner that is resistant to ignition

- ✓ Creates safety features such as buffers between fuels and neighborhoods, designated evacuation routes, and internal neighborhood safety zones
- ✓ Makes sure fire adapted community features, activities, and behaviors are maintained over time
- ✓ Has leaders and residents who coordinate, plan and collaborate to leverage their resources to reduce wildfire risk while increasing community resiliency



Embers emanating from a rapidly moving, windblown wildfire pose the greatest hazard to structures in Chandler Heights.

This type fuel bed produces significant windblown embers.

Figure 1: Chandler Heights CWPP Vicinity Map

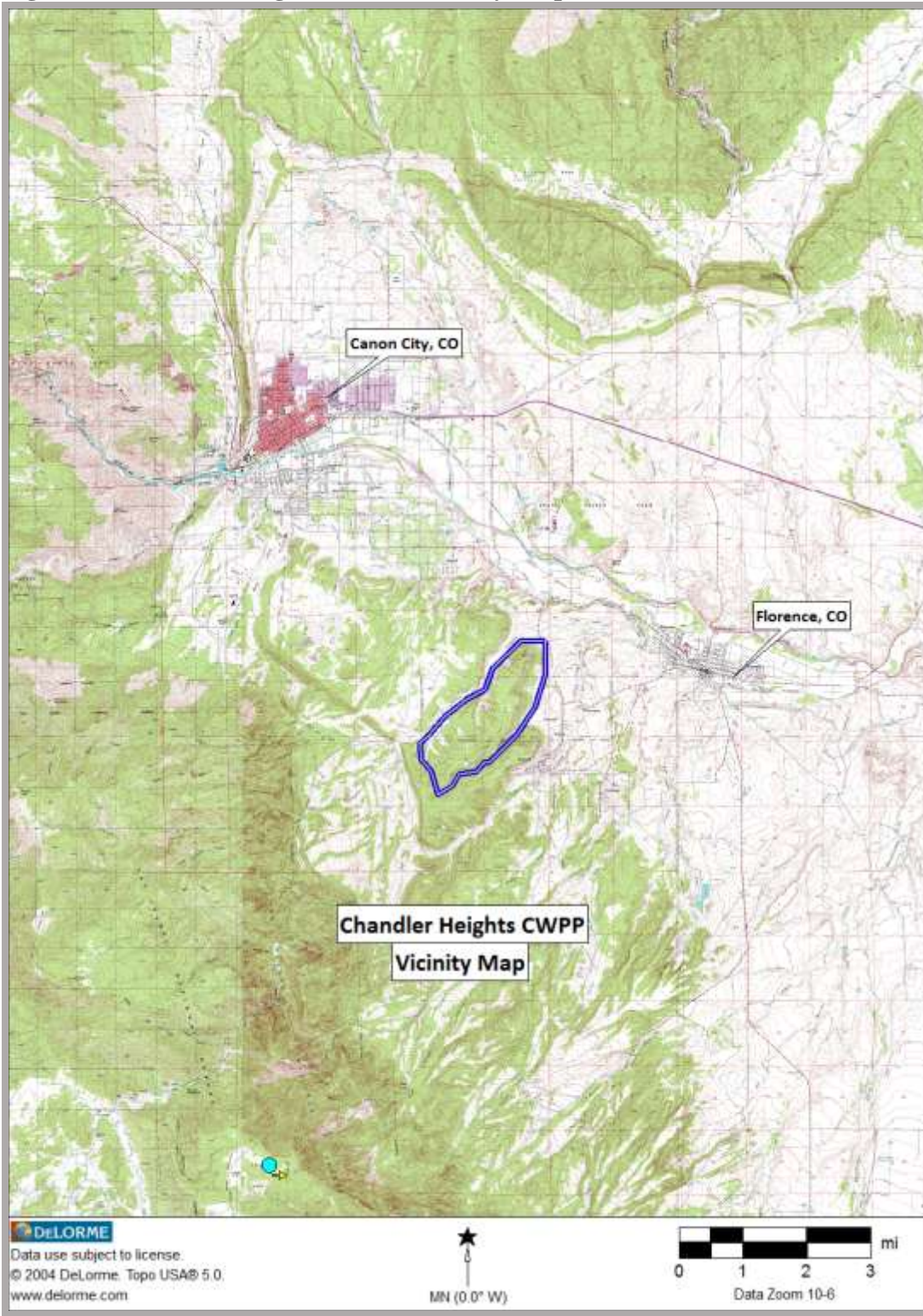

III. CHANDLER HEIGHTS COMMUNITY ASSESSMENT

The overall risk to the community from wildland fire is Low. This section will discuss the factors considered and contributing to the overall rating. The assessment is based on two levels of information. **The Colorado Wildfire Risk Assessment Summary** report found in **Appendix L**: provides a wealth of broad scale information about the CH CWPP area. Site specific findings were also developed based on field reconnaissance, Core Team knowledge and stakeholders insights. Site specific information was used to complete the NFPA “Wildfire Hazard & Risk Assessment Score sheet.

Colorado Wildfire Risk Assessment (WRA) Summary Report

The Colorado WRA provides a consistent, comparable set of scientific results to be used as a foundation for wildfire mitigation and prevention planning in Colorado. Please refer to **Appendix L** for in depth discussions on individual risk rating factors. The Colorado WRA website has further detailed information for you at www.ColoradoWildfireRisk.com

Colorado WRA places heavy emphasis on structure and population density. That distorts the hazard rating substantially when an individual landowner is trying to understand how a wildfire in their vicinity is likely to impact them.

Concepts of Risk & Hazard

Simply stated, risk is the probability of an adverse occurrence and a structures reaction to same, while hazard is the intensity of the event that is likely to threaten the structure.

Assessment of wildfire risk incorporates the likelihood that a structured will experience an event and the structures susceptibility if it does. The susceptibility of home to wildfire depends on construction materials and design. Thus, the amount of damage will vary for homes of different materials and design, even for the same wildfire. Similarly, wildfire risk to structures will vary with fire intensity level, their occurrence probabilities, and structure susceptibility. Thus, “risk” is conceptualized jointly as the likelihood, intensity, and susceptibility to effects of wildfires on structures.

Wildfire Threat is the likelihood of an acre burning. Threat is derived by combining a number of landscape characteristics including surface fuels and canopy fuels, resultant fire behavior, historical fire occurrence, percentile weather derived from historical weather observations, and terrain conditions. These inputs are combined using analysis techniques based on established fire science.

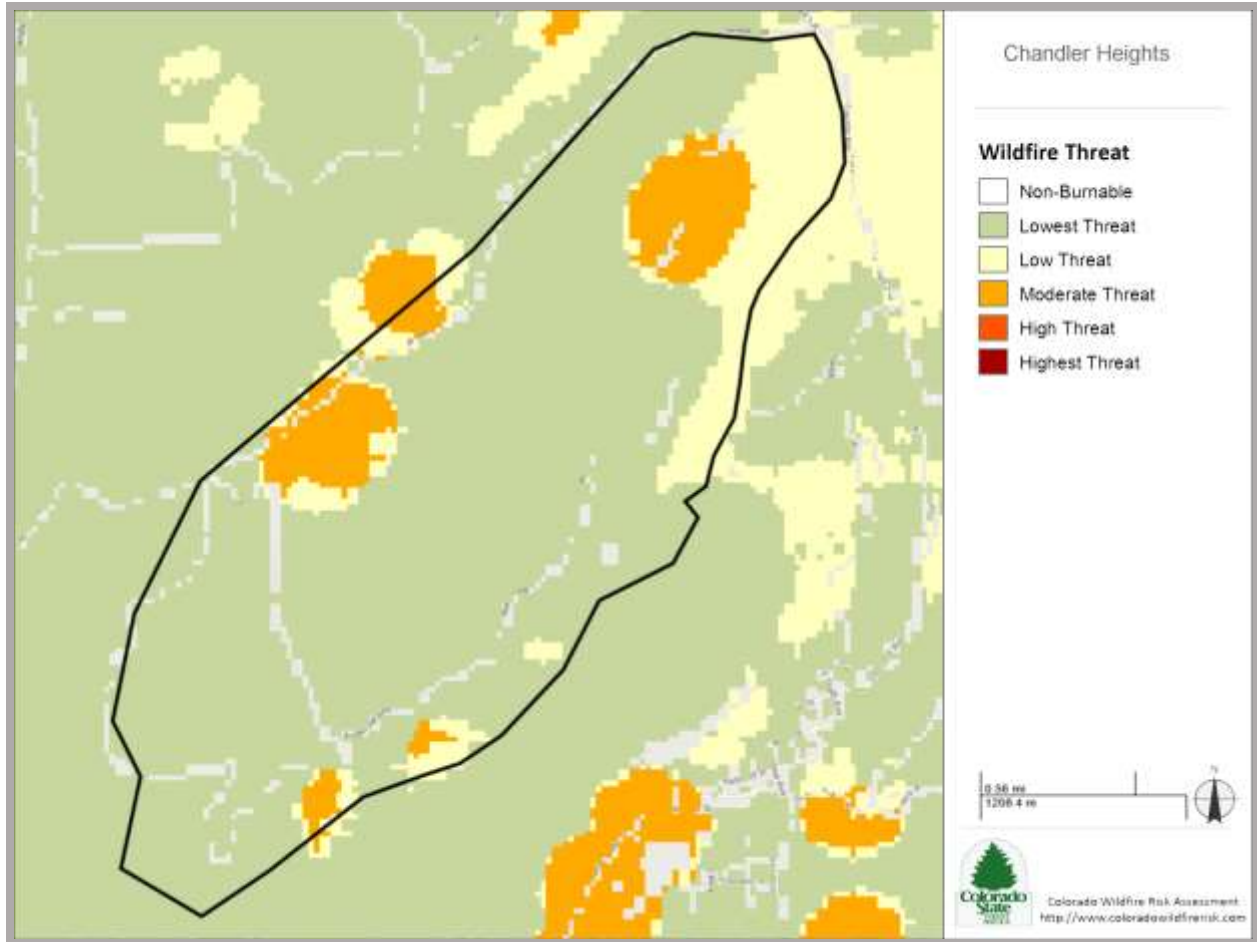

Fire Behavior

Fire behavior is the manner in which a fire reacts to the following environmental influences:

1. Fuels
2. Weather
3. Topography



Fire behavior characteristics are attributes of wildland fire that pertain to its spread, intensity, and growth. Fire behavior characteristics utilized in the Colorado WRA include fire type, rate of spread, flame length and fireline intensity (fire intensity scale). These metrics are used to determine the potential fire behavior under different weather scenarios. Areas that exhibit moderate to high fire behavior potential can be identified for mitigation treatments, especially if these areas are in close proximity to homes, business, or other assets.



The Royal Gorge fire of 2013 provides insight into how a wildfire is likely to behave in the Chandler Heights area.

Characteristic Rate of Spread

Characteristic Rate of Spread is the typical or representative rate of spread of a potential fire based on a weighted average of four percentile weather categories. Rate of spread is the speed with which a fire moves in a horizontal direction across the landscape, usually expressed in chains per hour (ch/hr) or feet per minute (ft/min). For purposes of the Colorado WRA, this measurement represents the maximum rate of spread of the fire front. Rate of Spread is used in the calculation of Wildfire Threat in the Colorado WRA.

Rate of spread is a fire behavior output, which is influenced by three environmental factors - fuels, weather, and topography. Weather is by far the most dynamic variable as it changes frequently.

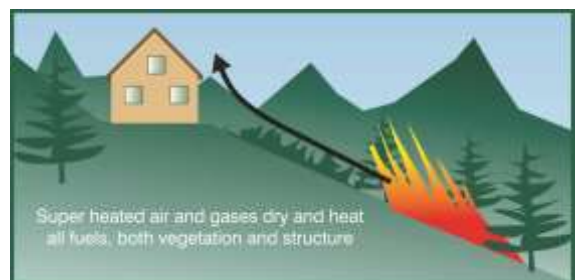

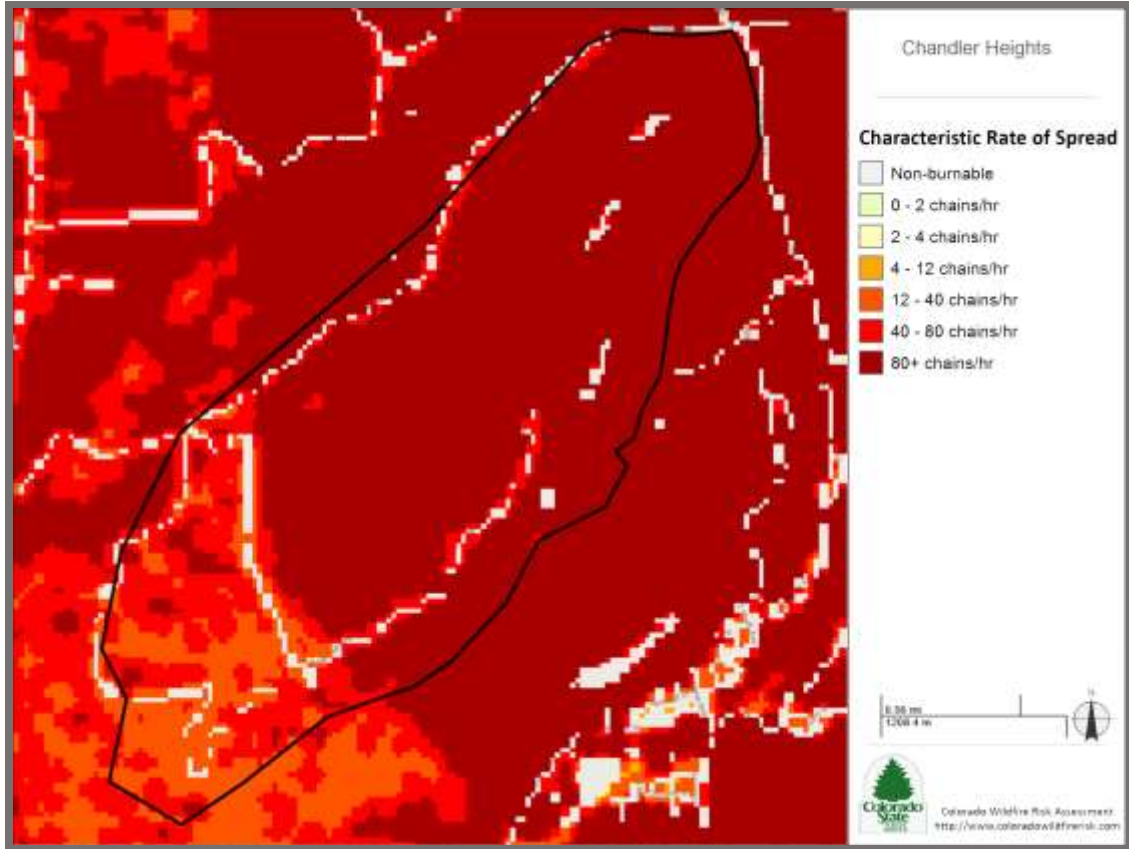

Characteristic Flame Length

Characteristic Flame Length is the typical or representative flame length of a potential fire based on a weighted average of four percentile weather categories. Flame Length is defined as the distance between the flame tip and the midpoint of the flame depth at the base of the flame, which is generally the ground surface. It is an indicator of fire intensity and is often used to estimate how much heat the fire is generating. Flame length is typically measured in feet (ft). Flame length is the measure of fire intensity used to generate the Fire Effects outputs for the Colorado WRA.

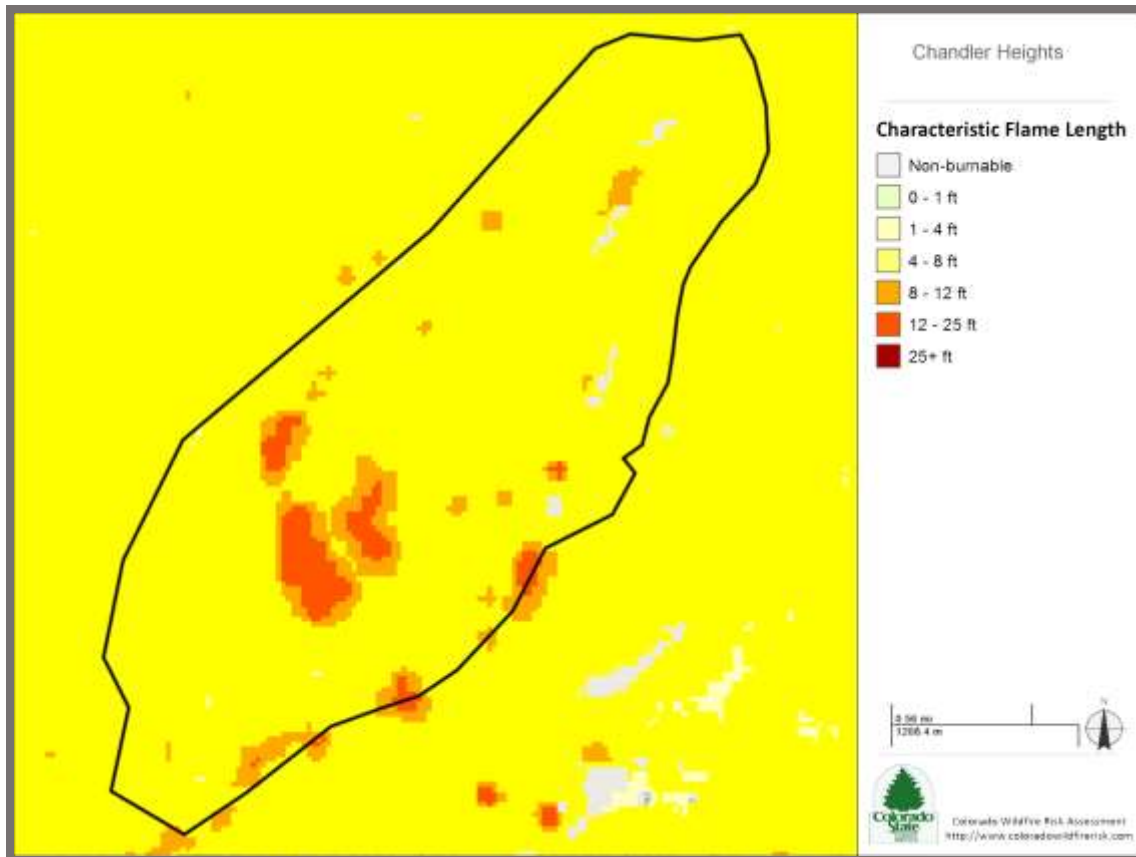
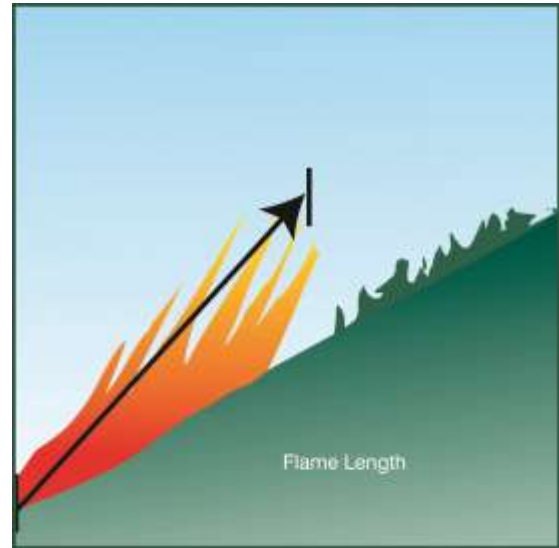

Fire Intensity Scale

Fire Intensity Scale (FIS) specifically identifies areas where significant fuel hazards and associated dangerous fire behavior potential exist. Similar to the Richter scale for earthquakes, FIS provides a standard scale to measure potential wildfire intensity. FIS consist of five (5) classes where the order of magnitude between classes is ten-fold. The minimum class, Class 1, represents very low wildfire intensities and the maximum class, Class 5, represents very high wildfire intensities.

1. Class 1, Lowest Intensity:
Very small, discontinuous flames, usually less than 1 foot in length; very low rate of spread; no spotting. Fires are typically easy to suppress by firefighters with basic training and non-specialized equipment.
2. Class 2, Low:
Small flames, usually less than two feet long; small amount of very short range spotting possible. Fires are easy to suppress by trained firefighters with protective equipment and specialized tools.
3. Class 3, Moderate:
Flames up to 8 feet in length; short-range spotting is possible. Trained firefighters will find these fires difficult to suppress without support from aircraft or engines, but bull dozers and plows are generally effective. Increasing potential for harm or damage to life and property.
4. Class 4, High:
Large Flames, up to 30 feet in length; short-range spotting common; medium range spotting possible. Direct attack by trained firefighters, engines, and dozers is generally ineffective, indirect attack may be effective. Significant potential for harm or damage to life and property.
5. Class 5, Highest Intensity:
Very large flames up to 150 feet in length; profuse short-range spotting, frequent long-range spotting; strong fire-induced winds. Indirect attack marginally effective at the head of the fire. Great potential for harm or damage to life and property.

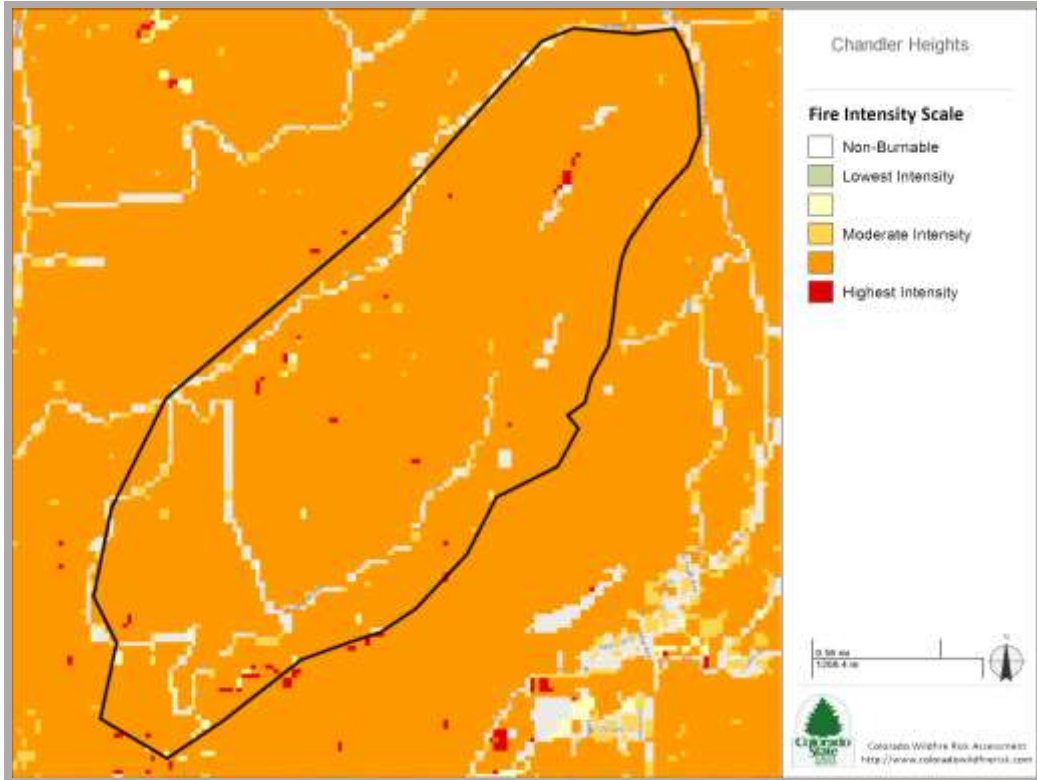

Fire Type

There are two primary fire types – surface fire and canopy fire. Canopy fire can be further subdivided into passive canopy fire and active canopy fire. A short description of each of these is provided below.

Surface Fire

A fire that spreads through surface fuel without consuming any overlying canopy fuel. Surface fuels include grass, timber litter, shrub/brush, slash and other dead or live vegetation within about 6 feet of the ground.



Passive Canopy Fire

A type of crown fire in which the crowns of individual trees or small groups of trees burn, but solid flaming in the canopy cannot be maintained except for short periods (Scott & Reinhardt, 2001).



Active Canopy Fire

A crown fire in which the entire fuel complex (canopy) is involved in flame, but the crowning phase remains dependent on heat released from surface fuel for continued spread (Scott & Reinhardt, 2001).



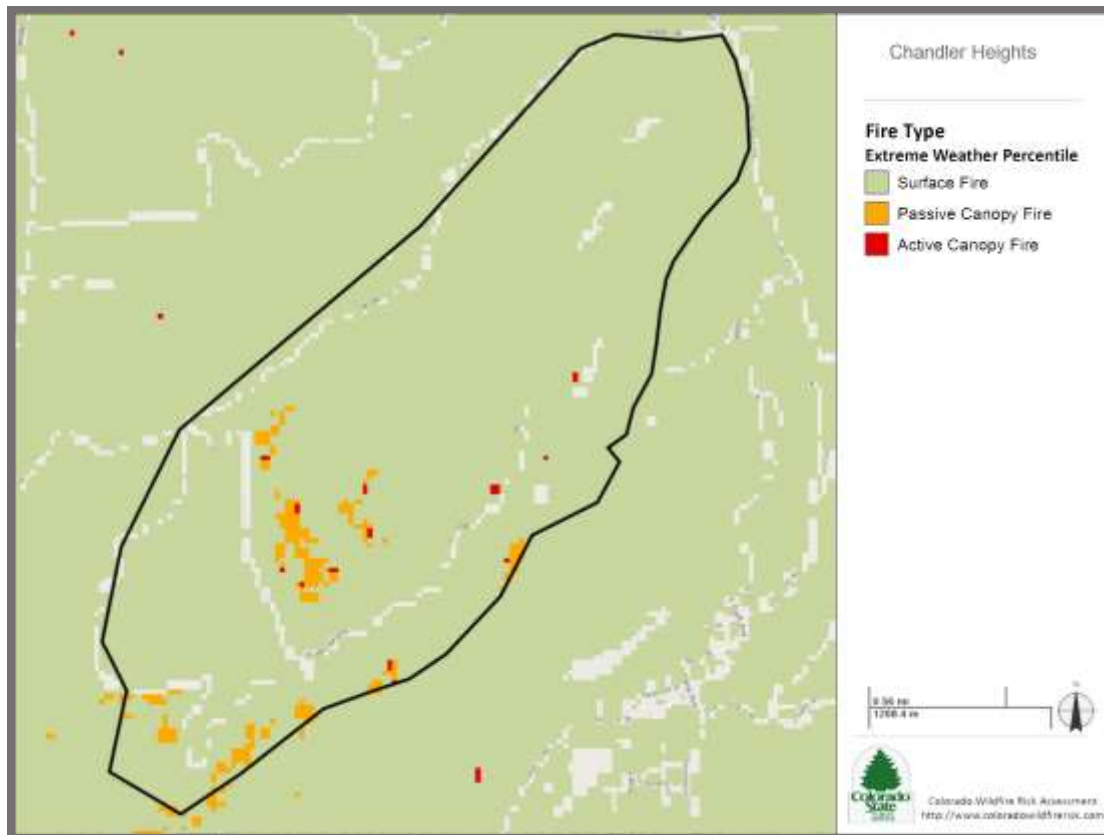

Surface Fuels

Surface fuels or fire behavior fuel models as they are technically referred to, contain the parameters required by the Rothermel (1972) surface fire spread model to compute surface fire behavior characteristics, including rate of spread, flame length, fireline intensity and other fire behavior metrics. As the name might suggest, surface fuels account only for surface fire potential. Canopy fire potential is computed through a separate but linked process. The Colorado WRA accounts for both surface and canopy fire potential in the fire behavior outputs. However, only surface fuels are shown in this report.

Surface fuels typically are categorized into one of four primary fuel types based on the primary carrier of the surface fire: 1) grass, 2) shrub/brush, 3) timber litter, and 4) slash. Two standard fire behavior fuel model sets have been published. The Fire Behavior Prediction System 1982 Fuel Model Set (Anderson, 1982) contains 13 fuel models, and the Fire Behavior Prediction System 2005 Fuel Model Set (Scott & Burgan, 2005) contains 40 fuel models. The Colorado WRA uses fuel models from the 2005 Fuel Model Set.

Here are a few representative photos of fuel models found in Chandler Heights area.



Surface Fuels	Description	Percent
GR 1	Short, Sparse Dry Climate Grass (Dynamic)	0.3 %
GR 2	Low Load, Dry Climate Grass (Dynamic)	44.1 %
GS 1	Low Load, Dry Climate Grass-Shrub (Dynamic)	0.7 %
GS 2	Moderate Load, Dry Climate Grass-Shrub (Dynamic)	46.8 %
SH 5	High Load, Humid Climate Grass-Shrub	0.2 %
SH 7	Very High Load, Dry Climate Shrub	0.1 %
TU 1	Light Load, Dry Climate Timber-Grass-Shrub	3.5 %
NB 1	Urban/Developed	3.3 %
NB 9	Bare Ground	0.7 %

Fuel Hazards

Some homes have varying degrees of wildfire hazard mitigation completed around them. Much more is needed. Some Homeowners have reduced ladder fuels adjacent to their structures by pruning the lower limbs from trees. This reduces the likelihood of a surface fire becoming a crown fire. Pruned limbs must be disposed of and not left on the ground.

All forest stands adjacent to structures with crown closures greater than forty percent are problematic. Continuous surface and crown fuel arrangement, both horizontal and vertical, render this area susceptible to torching, crown fire, and ignition by wind born embers, even under moderate weather conditions. The CO WRAP Fire Intensity Scale map for Chandler Heights shows a majority of the area as high or above fire intensity.

Local topography further aggravates fire behavior and control. Slopes range from ten to forty percent with most hillsides ranging from twenty to over forty (20->30%) percent. Small, non-descript drainages are abundant. They form chimneys where wildfires can make rapid runs uphill.

Table 4: Chandler Heights Fire Behavior Prediction

Fuel Model*	Rate of Spread (miles/hr.)	Flame length (feet)	1 hour fire size (acres)	1 hour Fire perimeter (miles)	Separation Distance ¹ (feet)
GR 2	1.25	8	337	3	33
GS 2	.5	7	51	1.2	28

Note: Highlighted zones are well beyond hand crew and engine suppression threshold.

¹Separation distance is the distance needed for humans to not sustain injury from a wildfire.

Spot fires will likely ignite up to a half mile from the flaming front. Crown fires are likely to spread at 0.83 miles per hour.

Slope also drives fire behavior. Fires burn more rapidly uphill because the flames tend to preheat fuels above them. While fire does burn downhill slower it can be pushed downhill by high winds or long range spotting.

Chart 2: Fire Behavior Increase as Slope Gets Steeper (0-45% slope)

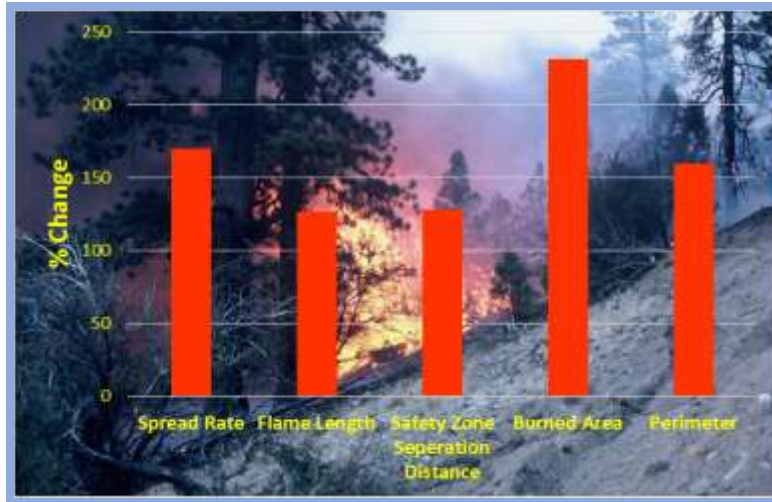

Table 5: Chandler Heights CWPP Area Slope Distribution

% Slope	% Area
0-22%	98
22-32%	2
32-44%	0
> 44%	0

Risk of Ignition and Wildfire Occurrence

Fremont County has experienced a number of large wildfires recently. The 3,218 acre Royal Gorge fire of 2013 has added energy to the CWPP process. It burned forty eight (48) structures.

Other fires in the region provide a serious warning for all people living in places prone to wildland fires. They include Black Forest, Waldo, Wetmore, Mason, Iron Mountain, Parkdale and the list goes on.

Low fuel moistures and low relative humidity are common in the area, as are periods of high winds. When dry, windy conditions coincide with a heat source the stage is set for large, troublesome wildfires.

Fires originating in or near the community are of most immediate concern, but fires starting well beyond the boundaries of the planning area can have profound effects. Rapid rates of spread and long distance spotting (starting a new fire by windblown embers) are the norms for fires in the vicinity. **Table 4: Chandler Heights Fire Behavior Prediction** provides insight into potential fire behavior on a bad day at Chandler Heights

IV Site Specific Wildfire Hazard & Risk Assessment

Chandler Heights was not mentioned as one of the communities of concern in the Fremont County Community Wildfire Protection Plan of 2008. The general subdivision layout and design found at Chandler Heights does not incorporate contemporary standards for development that are sensitive to wildfire implications. Normally, today a subdivision would be required to have two viable means of ingress and egress. Road grades would not be over 10% and lot layout would be sensitive to slope and not force a structure to be cantilevered over a heavily wooded slope or a driveway to be so steep it provides marginal access to a building site. There is very little that can be done to change pre-existing conditions in terms of layout and design. Individuals then, are left to assure that the home ignition zone is in good condition.

There are some rocky cliffs on the northeastern side of the planning unit that may provide a natural barrier to wildfires coming from the Williamsburg area IF winds are favorable and the convection column is relatively free of embers.

Values:

Eighteen (18) structures were triaged based on their anticipated ability to survive a wildfire in their vicinity without any human intervention to prevent them from burning. Five of the triaged structures (27%) are expected to survive a wildland fire in the neighborhood. The remaining thirteen structures (73%) will likely be destroyed when a wildfire occurs in the neighborhood. See the **Fire Control Features Maps** in **Appendix B** for structure triage results.

Chandler Heights Homeowners place a high premium on their natural surroundings and the visual quality of the landscape. Vast expanses of heavily burned, charred forest are objectionable whether structures burn or not. If the view is seriously impacted much of the intrinsic value of the home will also be lost.

Access:

Auckland Avenue provides the only vehicle access to Chandler Heights. It ends 2.36 miles beyond the entry gate. There is no other viable wheeled vehicle access to the area. The main gate is

locked but first responders have the combination. All but one leads to a structure pod that will likely be inhabited during fire season.

The primary road into CH exceeds 10% grade as it climbs on to the mesa. It also has a narrow, blind curve in the same vicinity. Driveways can be steeper. Most driveway terminus are inadequate for large structure fire equipment turnaround. Fortunately most structure pods are near enough to Auckland Avenue so fire equipment will not have to leave the main road.

Addresses are normally displayed at driveway intersections. Most home addresses are visible.

Evacuation route is currently limited to the main road. There is one location with light grass fuel loading that can be used as a temporary sanctuary if evacuation route is cut off. See **Appendix B: Fire Control Features Maps** for location of safety zone.

Risk:

Three kinds of risk are associated with wildland fire. The first concern is the risk to people trying to evacuate under less than optimal conditions. Second is the risk to firefighters attempting to protect property. Third is the risk wildfire poses to property. The concept of survivable space addresses both the second and third facets of risk under one umbrella.

Triage:

Structure triage was conducted on each parcel with buildings on it. Triage is a concise decision making process that is used if/when a wildfire threatens multiple structures simultaneously. See **Appendix D: Structure Triage** for a brief description of the triage process. The following observations are gleaned from on-site observations.

- ✓ Five of the structures are expected to survive. That leaves thirteen or 73% of the structures within Chandler Heights as likely to be destroyed or heavily damaged during a wildfire.
- ✓ Poor conditions in the structure ignition zone were the most prevalent problem found during triage. See the discussion of the home ignition zone starting on page 38.

It is important to understand the role of triage in this community wildfire protection plan. It is a quick, inexpensive way to determine overall community wildfire risk and helps to identify areas to focus improvement efforts. Its utility during an actual wildfire depends upon the nature of the wildfire. When only one structure is threatened, firefighting resources are usually assigned to protect that single structure, unless doing so creates an unacceptable safety hazard.

During a large wildfire scenario when more structures are threatened than there are firefighting resources to protect them, this triage work will help an Incident Commander assign scarce resources to the places where they have the best chance for success.

Maps developed for this Community Wildfire Protection Plan identify structure location and survivability. The CWPP is an ever evolving document and will be revised on a regular basis to reflect new information about structure survivability and other important fire control features in Chandler Heights.

Table 6: Structure Triage (See Appendix O for individual structure triage status)

Subdivision	# Structures Triage	% Survivable	% Non-Survivable
Chandler Heights	18	27	73

Note: Structure survivability is dynamic. As wildfire mitigation work is completed these numbers and the Fire Control Features Maps will be revised to reflect current structure status. Revisions will be agreed to by the Florence Fire Protection District and the Fremont County Office of Emergency Management. Fremont County will be responsible for maintaining the Geographic Information System that is used to develop said maps.

Table 7: Criteria Influencing Unlikely Survival Ratings

SURVIVAL UNLIKELY	CODE	# STRUCTURES ¹
Vegetation medium to heavy &/or slash. Anderson fuel models 8, 9, 10, 11,	A	7
Structure Ignition Zone <70 feet	B	7
Slope >21%	C	6
Topographic features adversely affect fire behavior	D	6
Areas exposed to unusually severe fire weather or strong dry winds	E	6
In close proximity to structures that can contribute to fire spread	F	0
Class C or non-rated roofing	G	0
Combustible siding and deck	H	8
Building close to or overhanging slope	I	6
Fire wood and other combustible human plunder on deck or within close proximity to structure	J	2
Hazardous materials close to structure	K	0

Criteria shaded in light yellow automatically drop survivability to Not Probable. Non shaded criteria often influence survivability and cumulatively may predispose a structure to Not Probable survivability status.

¹Thirteen structure pods had more than one problem

Evacuation:

This area can expect to be threatened by wildfires originating in both wildland areas around it and from wildfires originating within the area. Fires originating in light flashy grass and shrub fuels inside the planning area will dramatically complicate evacuations. There is one light fuel zone within the threatened area that can serve as a safe zone in an emergency situation but it is not the ideal solution.

Timing the initiation of an evacuation must consider the amount of time it will take to notify citizens and get them out of the area. It must also consider how rapidly the wildfire is likely to spread over an extended period of time. Fire spread rates are heavily dependent upon wind speed and slope. Evacuations are ordered and executed by the Fremont County Sheriff's Department, in consultation with wildfire personnel on scene. In most rapidly evolving situations it is wise to err on the side of the angels providing everyone plenty of time to leave the area safely.

Notification of an impending evacuation has been problematic on several wildfires lately. All homes are included in the Williamsburg reverse 911 system. Reverse 911 systems have had a difficult time keeping up with the wide array of communications options available to people today. People often convert from the traditional "land lines" to cellular phones without updating their contact information with emergency call centers. Chandler Heights does have cell phone coverage.

Fremont County has an "Alert Fremont" emergency notification system that will notify individuals with cell phones and Voice Over Internet Protocol (VOIP) phone numbers of emergencies in their area. It is important to have current contact information registered in that system. All landlines are automatically part of the "Reverse Notification System" and need do nothing. Cell phones must be entered in to the system by owners. The information on how to do this is on the main page of the Fremont County website – <http://www.fremontco.com> or directly at <http://www.fremontco.com/miscellaneous/fremont911.shtml>

See **Appendix N: Alert Fremont** for more information and a link to register your cell phone/s.

See section III of **Alert Fremont** for a few additional thoughts to facilitate timely evacuation in a wildfire setting.

Local Preparedness and Protection Capability

Chandler Heights is within Florence Fire Protection District (FFPD) coverage. The nearest FFPD fire station is in Florence, 4.5 miles away from the entry to CH. Initial attack in CH is expected to take 20 to 30 minutes. Canon City Fire Protection District has a station in southern Canon City

that is 5 miles away from CH gate. They are likely to respond under mutual aid agreement if available and requested by FFPD personnel.

BLM, Colorado State DPS, & USFS have initial attack resources stationed in Cañon City that can respond in lengthier timeframes if they are not already assigned to an active wildfire elsewhere.

If/When FFPD requests reinforcements or mutual aid from nearby departments it will take at least a half hour for that assistance to arrive on scene. Reinforcement availability is dependent upon wildfire workload at the time of the request.

The BLM has a Single Engine Air Tanker (SEAT) based at the Fremont County Airport during periods of high fire danger. A SEAT is not always stationed there or may be obligated to another wildfire.

Colorado State Department of Public Safety has a Type 3 helicopter with a ten person crew and bucket capability stationed at Fremont County Airport. It will respond if it is requested and not committed to another incident in the state at the time.

See **Table 7: Chandler Heights CWPP Available Wildland Fire Suppression Resources** for a complete list of wildland fire resources in close proximity to Chandler Heights.

Water Supply:

Water supply is a problem within the Chandler Heights area. There are a few cisterns at individual residences. They are not well marked, capacities differ and methods to hook fire apparatus to them vary.

Table 7: Chandler Heights CWPP Available Wildland Fire Suppression Resources

TYPE RESOURCE	TYPE	# ON HAND	# DESIRED
Florence Fire Protection District Station:			
Personnel		40	
Wildland firefighters (Carded)		15	
Brush trucks 150-250 gallons	6	2	
Brush Truck 300 gallons	6	2	
Engine 750 gallons		4	
Engine 1,000 gallons		3	+1
Tender 2,000 gallons		1	
Portable holding tanks		3	
Power saw kit (on Type 6 Engines)		2	
Fremont County Wildland Fire Team			
Wildland firefighters (Carded)		12	
Engine - 250 gallons	6	1	
Engine - 300 gallons	6	1	
Engine - 500 gallons	6	1	
Tender - 1500 gallon 6x6		1	
Water trailer- 450 gallon		1	
Portable holding tanks		2	
Colorado State Dept. Of Public Safety			
Wildland Firefighters (Carded)		10	
Engine	6	1	
Helicopter	3	1	
Power saw kit		2	
Wildland fire tool cache (20 person)	Mop up kits	1	
Bendix/King hand held radios		8	
Drip Torches		6	
BLM/USFS Pike/San Isabel NF (1)			
Wildland Firefighters (Carded)		26	
Engine	6	2	
Engine	4	1	
Power saw kit			
Portable pump kits	Mark 3	2	
Portable holding tanks	1500-2000 gal	3	
Wildland fire tool cache	100 person		
Single Engine Air Tanker/s (during very high fire danger)			

(1) Structure protection is the responsibility of fire protection districts and state. Federal partners provide assistance upon request and are most likely to do more wildland type suppression work, hence there isn't a need for heavy structure protection apparatus or resources.

Important Note:

While the Colorado Wildfire Risk Assessment program does not rate wildfire risk in Chandler Heights as significant relative to statewide concerns, it does highlight substantial hazard to individual structures when fire behavior intensity in the immediate vicinity is considered. The Wildfire Hazard & Risk Assessment Score sheet found on the next two pages summarizes field observations of the Chandler Heights community. It is based on National Fire Protection Association Wildland Urban Interface standards and criteria 1144.

Wildfire Hazard & Risk Assessment Score sheet

This document is based upon the NFPA 1144

WUI: Chandler Heights = High Hazard rating.....

A. Means of Access

1. Ingress and egress

a. Two or more roads in/out	0
b. One road in/out	7

7

2. Road width

a. ≥ 7.3 m (24 ft)	0 b.
≥ 6.1 m (20 ft) and < 7.3 m (24 ft)	2 c.
< 6.1 m (20 ft)	4

4

3. All-season road condition

a. Surfaced road, grade $< 5\%$	0 b.
Surfaced road, grade $> 5\%$	2 c.
Non-surfaced road, grade $< 5\%$	2 d.
Non-surfaced road, grade $> 5\%$	5 e.
Other than all-season	7

5

4. Fire service access

a. ≤ 91.4 m (300 ft) with turnaround	0 b.
> 91.4 m (300 ft) with turnaround	2 c.
< 91.4 m (300 ft) with no turnaround	4 d.
≥ 91.4 m (300 ft) with no turnaround	5

4

5. Street signs

a. Present [102 cm (4 in.) in size and reflectorized]	0
b. Not present	5

0

B. Vegetation (*fuel models*)

1. Characteristics of predominate vegetation within 91.4 m (300 ft)

a. Light (eg, grasses, forbs, sawgrasses, and tundra) <i>NFDRS Fuel Models A, C, L, N, S, and T</i>	5 b.
Medium (eg, light brush and small trees) <i>NFDRS Fuel Models D, E, F, H, P, Q, and U</i>	10 c.
Heavy (eg, dense brush, timber and hardwoods) <i>NFDRS Fuel Models B, G, and O</i>	20 d.
Slash (eg, timber harvesting residue) <i>NFDRS Fuel Models J, K, and L</i>	25

10

2. Defensible space

a. More than 30.48 m (100 ft) of vegetation treatment from the structure(s)	1 b.
21.6 m to 30.48 m (71 ft to 100 ft) of vegetation treatment from the structure(s)	3 c.
9.14 m to 21.3 m (30 ft to 70 ft) of vegetation treatment from the structure(s)	10 d.
< 9.14 m (30 ft) of vegetation treatment from the structure(s)	25

10

C. Topography within 9.1 m (300 ft) of structure(s)

1. Slope

a. Slope $\leq 9\%$	1 b.
Slope 10% to 20%	4 c.
Slope 21% to 30%	7 d.
Slope 31% to 40%	8 e.
Slope $> 41\%$	10

7

Wildfire Hazard & Risk Assessment Score sheet

D. Additional Rating Factors *(rate all that apply)*

1. Miscellaneous

a. Topographical features that adversely affect wildland fire behavior	0-5	2
b. Areas with a history of higher fire occurrence than surrounding areas due to special situations (eg, heavy lightning, railroads, escaped debris burning, and arson)	0-5	0
c. Areas that are periodically exposed to unusually severe fire weather and strong dry winds	0-5	5
d. Separation of adjacent structures that can contribute to fire spread	0-5	0

E. Roofing Assembly

1. Roof class

a. Class A roof	0	0
b. Class B roof	3	
c. Class C roof	15	
d. Nonrated	25	

F. Building Construction

1. Materials *(predominate)*

a. Noncombustible/fire-resistive siding, eaves, and deck	0	5
b. Noncombustible/fire-resistive siding and combustible deck	5	
c. Combustible siding and deck	10	

2. Building setback relative to slopes of 30% or more

a. ≥ 9.14 m (30 ft) to slope	1	5
b. < 9.14 m (30 ft) to slope	5	

G. Available Fire Protection

1. Water source availability

a. Pressurized water source availability - 1892.7 L/min (500 gpm) hydrants ≤ 304.8 m (1000 ft) apart	0	10
b. Pressurized water source availability - 946.4 L/min (250 gpm) hydrants ≤ 304.8 m (1000 ft) apart	1	
c. Non-pressurized water source availability (off site) - ≥ 946.4 L/min (250 gpm) continuous for 2 hours	3	
d. Non-pressurized water source availability (off site) - < 946.4 L/min (250 gpm) continuous for 2 hours	5	
e. Water unavailable	10	

2. Organized response resources

a. Station ≤ 8 km (5 mi.) from structure	1	5
b. Station > 8 km (5 mi.) from structure	5	

3. Fixed fire protection

a. NFPA 13, 13R, 13D sprinkler system	0	5
b. None	5	

H. Placement of Gas and Electric Utilities

1. Placement of utilities

a. Both underground	0	3
b. One underground, one aboveground	3	
c. Both aboveground	5	

I. Totals for WUI *(total of all points)*

87

Hazard Assessment	Total Points
Low	< 40
Moderate	40-69
High	70-112
Extreme	

V. COMMUNITY MITIGATION PLAN

HOW BUILDINGS ARE IGNITED BY WILDFIRE

Although wildfire can threaten a building in three different ways (burning embers, direct flame contact, and radiant heat), ember exposure is the most significant cause of ignition. For example, windblown embers (firebrands) can directly ignite easily ignited materials such as a wood shake roof, lawn chairs, wood piles, mulch, pine needles, or debris that has accumulated in gutters, roof valleys, or around dormers. Other combustible building components, such as siding or a deck, would be vulnerable to the flames or radiant heat from these more easily ignited materials. Gable ends and open eave vents are also vulnerable to the entry of embers, which can then ignite combustible items in attic spaces. Because embers can travel a long distance when carried up by convection currents, a wildfire is still a threat even if it is miles away.

Research confirms that certain key characteristics determine which buildings burn and which buildings survive. Keeping property free of debris and maintaining fire resistant landscaping reduces the likelihood of building ignition.

Everyday preparedness actions are important, such as creating a fuels free (mulch free) zone within five feet of the building's foundation, moving firewood piles and propane tanks away from buildings, keeping roofs clean, keeping combustible landscape plants away from buildings, and disposing of landscape trimmings. These preparatory actions must be regularly performed *before* a wildfire occurs to improve the survivability of people and property.

Home Ignition Zone

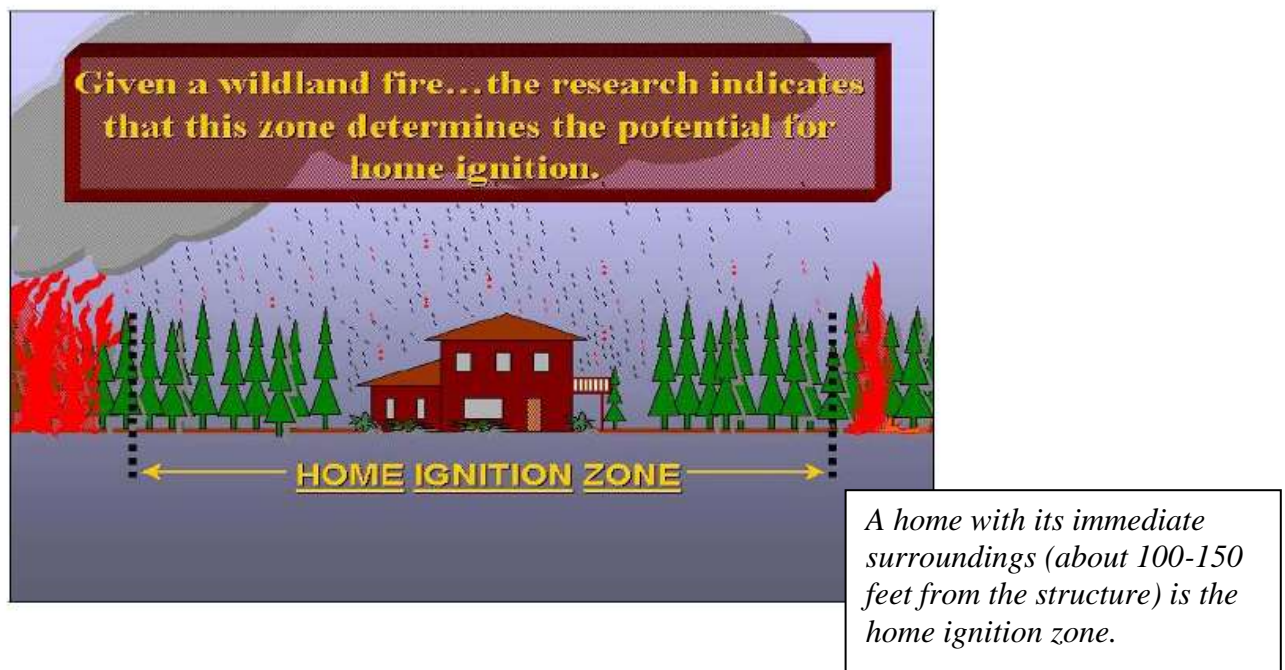

Recent research into the cause for loss of homes during wildfires indicates that home ignitability, rather than wildland fuels, is the principal cause of home losses during wildland/urban interface fires. Key items are flammable roofing materials (e.g. cedar shingles) and the presence of burnable vegetation (e.g. ornamental trees, shrubs, wood piles, and pine needle accumulation) immediately adjacent to homes (Cohen, 1999).

The home ignition zone includes a home and its immediate surroundings within 100 to 150 feet of the structure. Fuel conditions within this zone, to a large degree, will determine whether a home will survive a wildfire. High intensity fire behavior beyond the home ignition zone does not transfer enough energy directly from its flames to ignite a wooden structure. The fuels surrounding a home within the home ignition zone principally determine the potential for directly igniting the home. Firebrands lofted from extreme wildfires must directly ignite on a structure to be an effective ignition source. If firebrand ignitions occur in the fuels surrounding a home, then those fuels determine the home's ignition potential. Thus, regardless from how far firebrands travel a home's exterior materials and design and fuels in the home ignition zone determine its ignition potential from firebrands.

The primary and ultimate responsibility for home wildfire protection lies with private homeowners, not public land management agencies (or taxpayers). It is critical that special attention be given to reducing fuels in the home ignition zone around structures to improve their chances of surviving a wildfire. This includes insuring that there are no combustible materials like concentrations of pine needles, dry grass, hay or straw, firewood, deck furniture, household trash, flammable materials such as gasoline, diesel or paint thinners, paper boxes, and fabrics near the structure or in the home ignition zone for firebrands to land on. In the past few years research has found that a significant number of homes destroyed in wildfires burned as the result of the presence of combustible materials within the home ignition zone. Some homes ignited as much as 8 hours after the fire front passed. Reducing places for embers to penetrate the home such as open windows and vents also improves structure survivability.

Survivable Space:

Survivable space is an area around structures where fuels and vegetation are treated, cleared or reduced to slow the spread of wildfire towards the structure and lower the intensity of the fire as it passes the developed area. It also reduces chances of structure fire moving from the building to surrounding vegetation. Survivable space can provide room for firefighters to do their jobs. A house is likely to withstand a wildfire if vegetation is managed to reduce a fire's intensity. Structure design and construction also influence its survivability when a wildfire passes through the neighborhood. Removing flammable materials such as firewood, lumber and gasoline from the decks and base of structures will pay big dividends when an ember storm hits the home.

The concept of "defensible" space assumes that there will be sufficient wildfire personnel and equipment to actively protect each threatened structure. This assumption is accurate when only one or two structures are imperiled. When numerous structures are threatened simultaneously

there aren't enough firefighting resources available in Fremont County to protect them all. Mutual aid assistance from other fire departments in the region need time to mobilize and take effective action during large incidents.

Survivable space around a structure is the key to assuring that a home is still standing after a major wildfire. ***A structure is survivable IF it can withstand being overrun by a high intensity wildfire without any on site intervention by wildfire personnel.*** This requires close attention to structure design, construction, and its relationship to combustible natural and manmade plunder.

Effective survivable space is the Homeowners' most reliable means of providing wildfire protection for their structures. This is especially true in Chandler Heights terrain, and homeownership patterns in CH make landscape level fuel modification difficult. ***The key to individual structure survival is Survivable Space and good "Fire Wise" practices immediately adjacent to structures.***

During periods of high to extreme fire danger a wildfire will rapidly exceed the suppression capability of the local fire suppression forces. **Table 4: Chandler Heights Fire Behavior Prediction** displays the difficult position firefighters will face on a dry, windy day. Hand crews are effective when flame lengths are less than four feet. On a bad day 100 percent (100%) of Chandler Heights is expected to exceed four foot flame lengths. The size of a fire within the first hour is also expected to grow beyond local initial attack capability during periods of high thru extreme fire danger.

Homeowners should not expect much protection intervention if/when a large fire burns through the area. The harsh realities of evacuations, triage and coordinating attack with mutual aid forces will consume local fire forces for several hours. ***Fire Wise rated survivable space is the key to structures surviving on their own. Do it now and maintain it.***

In some cases, sizeable effort has been spent developing defensible space around quality homes perched on the edge of a steep slope with heavy vegetation below the structure. Unfortunately the trajectory of the flames will intersect the structure, exposing it to direct contact with flames. The County should encourage people to set new homes back from the edge of steep, brushy slopes using the guidelines provided in "**Protecting Your Home from Wildfire - Creating Wildfire Defensible Space Zones**", Quick Guide Series Fire 2012-1 available on the CSFS website and included in this CWPP as **Appendix M**.

Chart 3: Slope Impact on Survivable Space

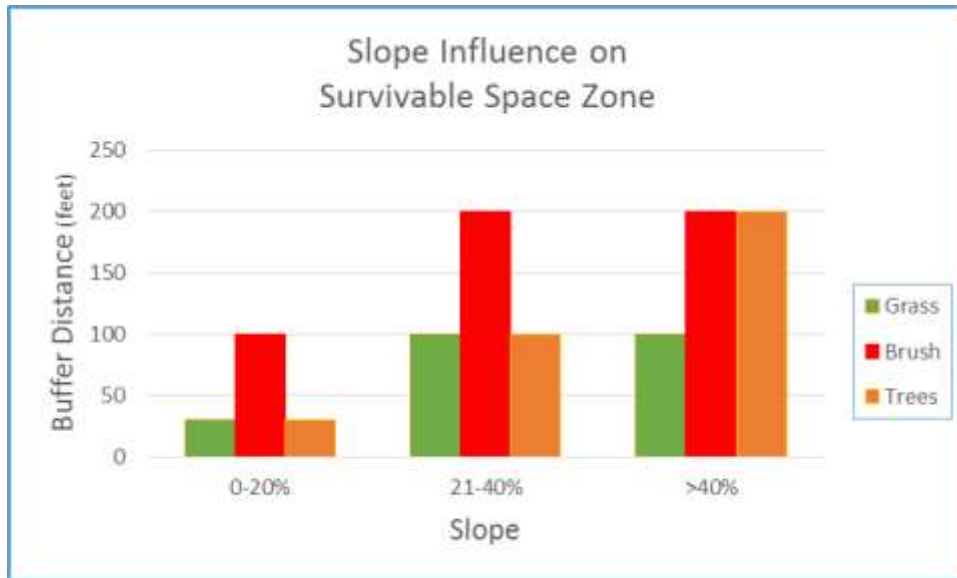

This chart indicates how far thinning needs to be done above and below a structure based on the slope it is on or adjacent to. It is also a good source to determine how far back from a slope to set a new structure.

State Tax Incentives for Wildfire Hazard Mitigation:

On April 4, 2013 the Governor signed House Bill 13-1012 that extend the deduction until January 1, 2025 to encourage more residents of the Wildland Urban Interface to mitigate wildfire hazards around their homes. House Bill 13-1012 extended tax incentives that allow Homeowners to deduct the actual costs of their wildfire mitigation, up to \$2,500 from their taxable income. The program allows each landowner to get credit for fifty percent of the cost of wildfire mitigation up to a total of \$2,500 per year. To get the full credit the total mitigation costs must be \$5,000 or greater. The work must be done in accord with an existing Community Wildfire Protection Plan to qualify.

This is a good incentive for individual Homeowners to improve survivable space around their structures.

Education and Information:

Dollar for dollar, one of the best ways to improve community wildfire resilience is wildfire awareness activities such as brochures, public service announcements, workshops, fire danger signs and informal discussions in the neighborhood. Fremont County has a FireWise trailer that they take to various gatherings in the County. It contains materials and displays that highlight the benefits of FireWise concepts. The trailer is available for property and home owners associations to use for

member information exchanges. The Royal Gorge fire provides a reminder and “teachable moment” to focus Chandler Heights Homeowners on the realities of the environment in which they live. Like all teachable moments it is not likely to last very long.

Fuel Hazard Reduction:

Individual owners have done varying degrees of wildfire mitigation work around their structures and along their driveways. Much more work is needed to mitigate wildfire hazards within Chandler Heights

Colorado State Forest Service personnel will provide risk assessments for structures for a fifty dollar fee.

Treatment Costs:

Treatment costs for survivable space and shaded fuelbreak work are highly variable depending on the amount of thinning and slash disposal to be done and the relative care involved in doing the work. Hand crews working next to structures and chipping the slash will cost from \$1,000 to \$2,000 per acre. Mechanical thinning with a hydro-ax type machine will normally cost from \$400 to \$700 per acre depending on tree density, slope and rockiness.

Slash Disposal:

Dealing with the waste material generated by wildfire hazard mitigation is a persistent problem throughout the Wildland Urban Interface.

CHHOA first priority as a community will be to treat fuels along Auckland Avenue. This will begin to improve evacuee safety during egress from the area. With sixty (60) foot road rights of ways in the development, they will be able to work within thirty (30) feet of the centerline without individual landowner authorization. Ideally the fuel reduction zone would be at least seventy five (75) feet on each side of the road. It is hoped that once property owners see the extent of thinning needed they will be willing to approve additional hazard mitigation beyond the platted ROWs.

Colorado State Forest Service in Cañon City has an informal business card collection of local contractors that do wildfire hazard reduction work. They can be reached at (719) 275-6865 for current listing.

Wildfire Suppression Infrastructure:

Water Supply:

All homes have cisterns but they are difficult to find, capacities vary and removing water from them with wildfire apparatus may be problematic. They need to be inventoried and marked on the ground and included on the fire control features map.

It would be wise to explore the feasibility of drilling a dedicated fire well in Chandler Heights. Such a well will provide water for both wildland and individual structure fire suppression throughout the year.

Turnarounds:

Accommodations for turning vehicles around near the end of the road are critical for fire suppression purposes. Space is inadequate to turn around fire equipment at the end of most driveways. In many cases there is little room to construct turnarounds at the end of driveways so parking fire apparatus on access roads and running hose lays to structures is the only option. See **Appendix H: Road & Driveway Specifications** for design specifics.

Pistol turns offer an alternative to full blown 45 foot radius cul de sacs that should be considered to provide viable turn around space at the end of driveways.

Fire Control Features/Triage Maps:

The maps developed for this Community Wildfire Protection Plan provide invaluable information for wildland firefighting. Reinforcements and mutual aid folks often struggle with road layout and fire suppression opportunities without good maps. Communications can be enhanced by providing high quality maps that show important features. See **Appendix B: Fire Control Features Maps** for locations of homes with/without survivable space, water locations, staging areas, safety zones, aviation hazards etc.

Fremont County Office of Emergency Management will provide a set of maps and orthophotos to dispatchers, first responders, the Sheriff's department and Colorado State Forest Service. They will also have a few reserved to distribute during the inevitable emergency. They update triage information on these maps on a regular basis.

Evacuation Planning:

One factor to consider and address directly in the Evacuation Plan is the amount of time it will take to fully implement the evacuation in comparison to the expected fire behavior described in **Table 4: Chandler Heights Fire Behavior Prediction**. Fire spread rates of half mile per hour and spotting distances of close to a quarter mile mean that evacuations should probably be implemented when any fire is within 3 miles of a structure during high or greater fire danger periods.

An evacuation simulation exercise would be an eye-opener for residents and should be scheduled for summer 2017. This test run will give everyone involved a better sense of the task at hand.

There is also a need to develop an inventory of residents with special transportation needs and limits to mobility. Providing oxygen or other medical accommodations for evacuees during the evacuation is critical.

It is also time for all residents in the CWPP analysis area to check their phone status in the **Alert Fremont** 911 Emergency Notification system. See **Appendix N** for details.

Evacuation Options:

Unfortunately Auckland Avenue provides the only ingress and egress to Chandler Heights. During a rapidly evolving wildfire or if the fire has burned across the evacuation route, there is only one potential Safety Zones in CH. Safety Zones should be considered a stop gap solution as they are not well suited for situations where the evacuation order is expected to last for more than a few hours. It is important to document any agreement with a landowner to use their property as an emergency safety zone in event of a wildfire.

V. IMPLEMENTATION & MONITORING

Implementation:

Table 9: Implementation Items Priority & Cost lists all the mitigation actions/projects identified in this CWPP. There are also an estimated twelve (12) structures that need to have their survivable space improved.

Table 8: Recommended Items Priority & Cost

Mitigation Action	Priority	Estimated Cost (\$s)
Conduct FireWise and Survivable Space Workshops and provide onsite advice	1	1,200
Survivable Space Around All Structures (0-\$2,000/lot)	2	36,000
Encourage residents to stay current in the E911 system (Public Service Announcements	3	0
Print & distribute Fire Control Features Maps (20 sets) @\$20/set	4	400
Inventory and mark residential cisterns	5	100
Negotiate and document agreement to use Safety Zone	6	0
Reduce crown fire potential along 2.3 miles of major evacuation routes	7	16,000
Install 30,000 gallon cistern	8	100,000
Evacuation Simulation	9	1,000
Purchase a 2,000 gallon engine for FFPD	10	450,000
Total		\$ 604,700

Items shaded in green are likely eligible for grant funding.

Monitoring:

Plans do not implement themselves. Monitoring progress is a crucial part of seeing any plan through to completion. Given the values at risk in Chandler Heights, it will be important to take a pulse on accomplishments on an annual basis. We expect more homes to become survivable and maps will have to be revised to reflect the work that has been accomplished. The OEM will revisit the CWPP and associated accomplishments each fall and will get new maps printed as accomplishments warrant.

Table 10: Action Plan for Completing the Chandler Heights CWPP, identifies the responsibilities and tasks necessary to accomplish the job at hand. The priorities and responsibilities have been negotiated and agreed to by the Core Team and the various named individuals.

Table 9: Action Plan for Completing the Chandler Heights CWPP

Mitigation Action	Target Date	Assigned to	Completed ✓
Conduct FireWise and Survivable Space Workshops and provide onsite advice	TBD	CSFS	
Survivable Space Around All Structures (0 \$2,000/lot)	2020	Individual home owners	
Encourage residents to stay current in the E911 system (Public Service Announcements)	Ongoing	CHHOA	
Print & distribute Fire Control Features Maps (20 sets) @\$10/set	7/15/17	Steve Morrisey Fremont County OEM	
Inventory and mark residential cisterns	7/15/17	CHHOA	
Negotiate and document agreement to use Safety Zone	7/15/17	CHHOA	
Reduce crown fire potential along 2.3 miles of major evacuation routes	2020	CHHOA	
Construct 30,000 gallon cistern	2022	CHHOA	
Purchase a 1,000 gallon engine for FFPD	2020	Florence FPD Chief	

Items shaded in green are likely eligible for grant funding.

Chandler Heights CWPP

- Accidental avc
- Existing 2 Track
- Survival Unclear
- Survival Likely
- Safety Zone



105°12'0"W 105°11'30"W 105°11'0"W 105°10'30"W 105°10'0"W



Chandler Heights Triage & Fire Control Features

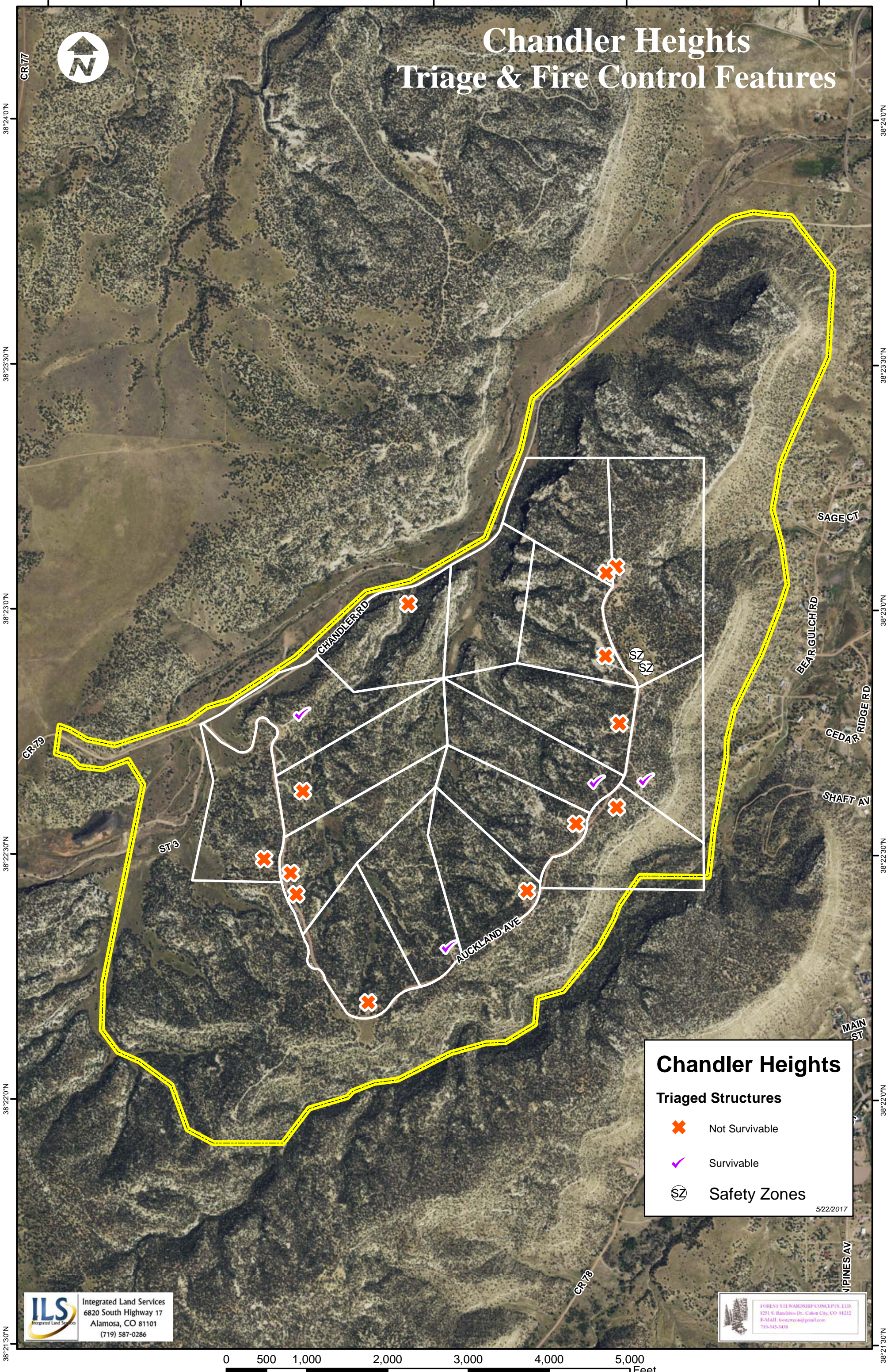

Chandler Heights

Triaged Structures

-  Not Survivable
-  Survivable
-  Safety Zones

5/22/2017

ILS
Integrated Land Services
6820 South Highway 17
Alamosa, CO 81101
(719) 587-0286

FORLEST STRATEGIC CONCEPTS, LTD.
1251 S. Ranchitos Dr., Canon City, CO 81212
EMAIL: forlestco@gmail.com
719-345-3438

0 500 1,000 2,000 3,000 4,000 5,000 Feet

38°21'30"N

38°22'0"N

38°22'30"N

38°23'0"N

38°23'30"N

38°24'0"N

38°21'30"N

38°22'0"N

38°22'30"N

38°23'0"N

38°23'30"N

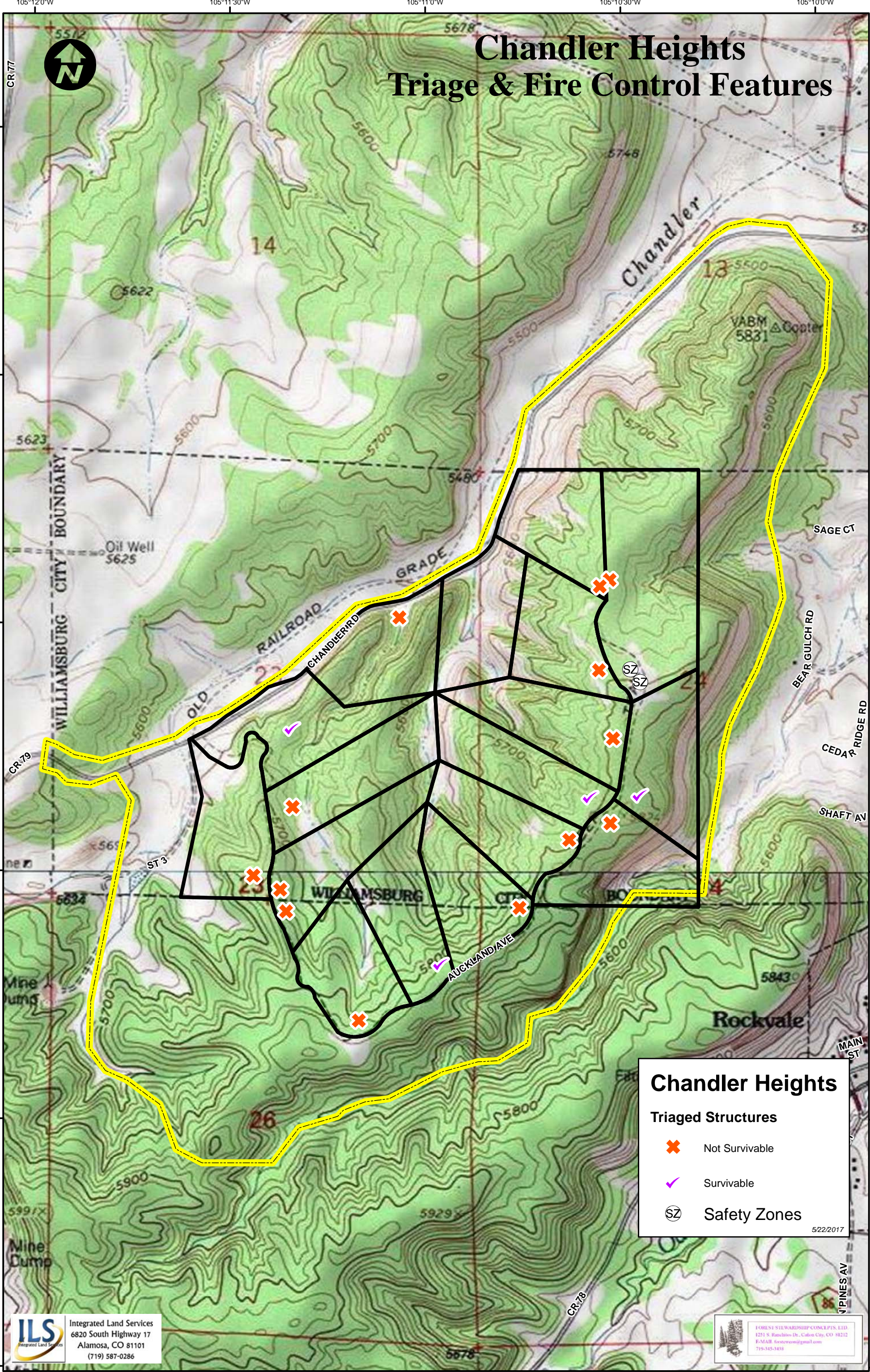

38°24'0"N

Chandler Heights Triage & Fire Control Features



Chandler Heights

Triaged Structures

-  Not Survivable
-  Survivable
-  Safety Zones

5/22/2017

ILS Integrated Land Services
6820 South Highway 17
Alamosa, CO 81101
(719) 587-0286

FORREST & FORREST CONCEPTS, LTD.
1251 S. Ranchitos Dr., Canon City, CO 81212
E-MAIL: forrestco@gmail.com
719-345-3438

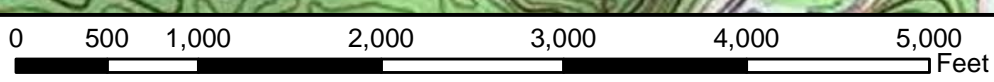

APPENDIX C – Evacuation Planning Guidelines

Background

The growth of urban development in forested wildland areas in recent years has resulted in a potentially hazardous situation. People are attracted to forested areas seeking solitude and to escape the pressures of everyday life. Large land holdings have been subdivided into small, affordable acreages for home and recreational cabin sites or remote homes. The new generation of small lot landowners value individual trees and have often built their cabins under the cover of or within these overstocked forests. Structures are constructed on prominent points or ridge tops for the view or they are tucked into the forest canopy seeking solitude. In order to minimize the impact of their presence on the land, driveways are often narrow with inadequate opportunities to turn around at the building site. At the same time, wildfires have been aggressively suppressed allowing dead fuels to accumulate to alarming levels and young trees to establish in high densities. These ladder fuels provide a “leg up” for a wildfire to burn into the tree crowns and move rapidly under windy conditions. Little attention has been paid by landowners to the potential destructive capacity of an uncontrolled wildfire.

In an emergency wildfire situation that threatens the lives and property of residents in the area, the Fremont County sheriff, in consultation with the Florence FPD, fire suppression teams and land managing agencies, may recommend that residents evacuate to a safe area. Prior evacuation planning is essential to implement this action effectively.

By definition, evacuation is a protective action—moving people from a place of danger to a place of relative safety. It is a temporary mass movement of people that collectively emerges in coping with threats to area residents and visitors.

An Evacuation Plan will facilitate the orderly evacuation during an emergency wildfire situation. Step by step actions provide critical information and guidance for fire suppression and law enforcement personnel during an emergency situation. Each subdivision, home site development area or land owner association should be strongly encouraged to develop an evacuation plan for their area that identifies potential evacuation routes and critical information (locked gates, inadequate bridges, etc) for a variety of wildfire threat scenarios.

Residences of people with mobility issues and special needs, that effect their ability to spontaneously evacuate, should be documented in evacuation plans and highlighted on Fire Control Features maps so appropriate assistance can be provided in a timely manner.

Critical Contacts

Contact	Phone Number
Fremont County Sheriff	719 276-5555
Fremont County Office of Emergency Management	719 276-7422
Colorado State Patrol	719 784-3275
Colorado State Dept. of Public Safety	303 239-4400
Colorado Department of Homeland Security and Emergency Management	720 852-6600
Florence Fire Protection District	719 784-3611
Royal Gorge Field Office BLM	719 269-8500
American Red Cross	800 733-2767

Check List When Potential for Evacuation Exists

- 1) Close back country roads and trails at trail heads.
- 2) Special needs residents are notified and appropriate measures taken to facilitate their evacuation.
- 3) Post on bulletin boards information regarding fire danger.
- 4) Set up a local Information Center where residents and visitors can access up-to-date information and status regarding wildfires that pose a threat to the area.
- 5) Provide routine updates on wildfire conditions for local radio and television stations as the threat increases.
- 6) When the fire suppression team and land managing agencies (BLM, US Forest Service and Colorado State Forest Service) believe evacuation may become necessary, notify the Fremont County Sheriff and County Office of Emergency Management.
- 7) Fire suppression team and land managing agency managers should meet and coordinate with the Sheriff and County Emergency Management Office to decide if an evacuation is necessary. The decision to evacuate should be made and implemented well before the evacuation needs to be completed. Local conditions and the fire's rate of advance will dictate timing and trigger points.
- 8) The Sheriff, after consultation with the land managing agencies and County Emergency Management Director makes the decision to evacuate the threatened area and implements the actual evacuation.
- 9) Notify residents and visitors of the Order to Evacuate:
 - Siren to alert visitors in the back country. Law enforcement patrol vehicles with public address systems announce evacuation order.
 - House-to-house verification that threatened home site developments are completely evacuated.
 - Law enforcement vehicles and ATVs drive back country roads and trails to assure evacuation.

- Use one color flagging to mark secondary roads/trails at their junction with the primary road (evacuation route) when notification is in progress then change to another color when verification is complete on that road/trail.
- 10) Drive evacuation routes installing free standing traffic control signs at key road intersections and opening locked gates or cutting fences to allow exit.
 - 11) CSDPS notify Federal Emergency Management Agency (FEMA)
 - 12) Notify Colorado State Patrol Assign law enforcement to direct traffic at critical road junctions.

The officer in charge of the evacuation will make the decision regarding which evacuation route to use at the time. Depending on the situation the decision may be to use any or all of the routes to evacuate the threatened area.

Emergency Evacuation Routes

Primary emergency evacuation routes are suggested but should be validated with landowners and land management agencies involved prior to the onset of an emergency need for evacuation. These primary evacuation routes should provide multiple opportunities for evacuating traffic to exit the area. Hazardous fuel concentrations should be treated along primary evacuation routes by creating shaded fuelbreaks to reduce canopy cover to 40 percent or less and treat slash and combustible debris within 200 to 300 feet of either side of the road. Tributary roads should be identified in local developments and treated similarly to facilitate a safe and orderly evacuation.

NEIGHBORHOOD	WAY IN & OUT	ROAD IDENTIFIERS
All but one home in Chandler Heights Community	Auckland Avenue south to CR 79	Auckland Ave. & CR 79
Single home accessed via CR 79	CR 79 northeast	CR 79

Safety Zones

Several Safety Zones are designated in the area. If/when fire behavior precludes exiting the area these Safety Zones will provide temporary sanctuary.

Estimated Time to Implement an Evacuation

The decision to evacuate a threatened area must be made well in advance of the time the fire is expected to threaten residents, visitors and facilities.

Fire Behavior and Evacuation Timing

Spread Component (SC) is the key fire danger component to monitor. The spread component is a numerical value derived by the National Fire Danger Rating System (NFDRS) from a mathematical model that integrates the effects of wind and slope with fuel bed and fuel particle properties to compute the forward rate of spread at the head of the fire. Output is in units of Chains per hour. A spread Component of 31 indicates a worst-case, forward rate of spread of approximately 31 chains per hour. A chain is an engineering scale consisting of 66 feet so a spread component of 31 chains/ hour equals a spread rate of 2,046 feet per hour or close to a half mile per hour.

The inputs required to calculate the SC are wind, slope, fine fuel moisture (including the effects of green herbaceous plants), and the moisture content of the foliage and twigs of living, woody plants.

Since characteristics through which the fire is burning are so basic in determining the forward rate of spread of the fire front, a unique SC table is required for each fuel type.

When considering spotting, the rich diversity of fuel types scattered throughout Chandler Height and the likelihood of wind, it may be prudent, when fire danger is Very High, to consider starting an evacuation process when fires are burning within 5 miles of down-wind subdivisions or home site development areas (urban interface area). Knowing the SC for the most prevalent fuel type between where the fire is and where the home site developments are can best refine this judgment call. With a SC of 44 a fire will cover 2 miles or more within 4 hours. If the SC is 22 the fire will cover at least one mile within 4 hours and 2 miles within 8 hours. If the SC is 11 the fire will cover two miles within 16 hours.

Remember the lessons of some Colorado fires:

- The Buffalo Creek Fire ran nearly eleven miles in 4.5 hours
- The Hayman Fire ran at least 16 miles in one afternoon

Timing

Evacuation planning needs to consider how long it will take to notify residents that an evacuation is necessary, how long it will take for them to get ready and start driving out of the area and then how long it takes to actually drive to a safe area. This determination should be made locally for each development area or subdivision and then validated before it is used during an emergency.

Every situation will be different but it is reasonable to estimate the minimum time required to be no less than 4 hours to complete the process. As much as three hours may be required to notify residents and visitors and get them started moving and another hour to get everyone out of the area. Residents and visitors closest to the advancing threat should be notified first. Once they are driving out of the area it will take them up to half an hour in most cases to exit the area if traffic is flowing at a rate of 10 to 20 miles per hour.

Driving time should be measured on each of the potential evacuation routes by driving at a conservative speed depending on road conditions and how many people are expected to be evacuated to approximate how long it would take to drive the route during an evacuation providing traffic was moving at about that rate. The following table displays the type of information that needs to be incorporated in the Evacuation Plan.

Travel Time for Evacuation Routes

Beginning Point	Ending Point	Time Required	Miles Traveled	Average Speed

GPS Locations for Critical Features and Facilities – This table provides GPS coordinate locations for critical points referred to.

Feature	GPS Location

Recommendations

- Establish and sign Safety Zones in areas where evacuation notification and implementation will be problematic and notify locals as to their location.
- Negotiate agreements with neighboring private land owners and land managing agencies to allow evacuation across their property on their roads and through their locked gates.
- Negotiate an agreement to thin fuels along the evacuation route between the subdivision or home development area and safe areas.
- Upgrade roads on evacuation routes by widening curves, providing water bars to prevent erosion and thinning fuels along these emergency exits.

- Construct and store freestanding “Fire Exit Directional Signs” or “Evacuation Route” for use in marking evacuation routes.
- Develop a specific evacuation procedure and assign responsibilities to County staff.

Appendix D: Structure Triage Criteria

Structure Triage

Triage in the community wildfire protection plan context is the determination of priorities for action during a wildfire. The process historically has rated the likelihood that wildfire personnel can safely and successfully defend a structure while it is being threatened by a wildfire.

There is one serious flaw in this approach; it assumes that there will be adequate resources available to take some form of meaningful fire suppression action to defend the structure. When more than one structure is imperiled by a wildfire in a rural setting it is highly unlikely a local volunteer fire department will have sufficient apparatus and personnel to “protect” multiple structures simultaneously. Mutual aid in rural Colorado may take several hours to get to the fire ground.

Assigning a “defensible” rating to a structure can also lull homeowners into complacency if they think the local fire department will make Herculean efforts to save their home. In most instances the structure will have to survive on its own.

To avoid creating any false impressions about the ability of wildfire suppression personnel to protect every structure regardless the magnitude of the incident, a structure’s chance of surviving a wildfire is rated as probable or not probable. This approach is much more realistic and should encourage property owners to look at their homes in a new light.

Many factors are considered when assigning a survivability rating to a structure. The triage process is highly subjective. Wildfire behavior and structure interactions are not well suited to a clear cut “yes” or “no” analysis. The table below describes criteria used to determine structure survivability. The factors have been extracted from the Wildfire Hazard & Risk Assessment score sheet found in “Living on the Edge” (Troy & Kennedy 2007) and is based on NFPA 1144 standards.

It is important to understand that there are no guarantees a structure with a “probable” survival rating will be standing after an intense wildfire occurs. Similarly, occasionally structures with a “not probable” survival assessment may endure a wildfire in spite of all rational analysis.

The survival rating is simply a reliable indicator of a probable outcome following a very dynamic, chaotic, unpredictable event. The rating has been assigned by an individual with over forty years of wildland fire experience considering the criteria below to make the prediction.

Survivability Criteria

PROBABLE	NOT PROBABLE	CODE
Vegetation light ~ Anderson fuel models 1 & 2	Vegetation medium to heavy &/or slash. Anderson fuel models 8, 9, 10, 11,	A
Structure Ignition Zone >70 feet	Structure Ignition Zone <70 feet	B
Slope <20%	Slope >21%	C
Topographic features minimize fire behavior	Topographic features adversely affect fire behavior	D
Area not exposed to unusually severe fire weather or strong dry winds	Areas exposed to unusually severe fire weather or strong dry winds	E
Separated from adjacent structures that can contribute to fire spread	In close proximity to structures that can contribute to fire spread	F
Class A & B roofing	Class C or non-rated roofing	G
Non-combustible/fire resistive siding, eaves & deck or combustible deck with no debris underneath	Combustible siding and deck	H
Building set back from slope appropriate distance	Building close to or overhanging slope	I
No fire wood or other combustible human plunder in close proximity to structure	Fire wood and other combustible human plunder on deck or within close proximity to structure	J
Hazardous materials appropriate distance away	Hazardous materials close to structure	K

Criteria shaded in light yellow automatically drop survivability to Not Probable. Non shaded criteria often influence survivability and cumulatively may predispose a structure to Not Probable survivability status.

NOTE: You will find that access, escape routes, turnarounds, safety zones and water supply are not factored into the survivability rating. These items are important for firefighter safety but do not influence structure survivability. Remember fire control personnel will most likely not be defending the structure; it will have to go it alone. Safety concerns and limited availability of firefighting resources preclude active intervention to protect structures.

Is Your Home Protected



From Wildfire Disaster?



A Homeowner's Guide
to Wildfire Retrofit

acknowledgments

The staff of the Institute for Business & Home Safety (IBHS) wishes to acknowledge the valuable input of all those involved in the preparation of this booklet. In particular, we extend our thanks to:

The IBHS Wildfire Committee Members
National Fire Protection Association
State Farm Fire and Casualty Company
National Institute of Standards & Technology
US Geological Survey
Insurance Services Office, Inc.
The Hartford Financial Services Group
California FAIR Plan Association
Allstate Insurance Company

Architectural Illustrations:
W. Spaulding, AIA

Photography:
Cover: Incident scenes; post-burn/damages
Courtesy National Interagency Fire Center, Boise, Idaho
Cover and page 1: Bitterroot National Forest, Montana
Courtesy National Interagency Fire Center, Boise, Idaho
Cover and page 2: Pine Barrens
© J Smalley, NJ
Opposite Table of Contents: Florida Wildfire
© AP/Wide World Photos

Disclaimer

The purpose of this document is to provide homeowners with guidance on ways to retrofit and build homes to reduce losses from wildfire damage. It contains suggestions and recommendations based on professional judgment, experience and research and is intended to serve only as a guide. The authors, contributors and publisher disclaim all warranties and guarantees with respect to the information in the document and assume no liability or responsibility with respect to the information.

“Nature...she pardons no mistakes.”

Ralph Waldo Emerson



© AP/Wide World Photos

An April 2001 Florida wildfire caused Olga Gutierrez to desperately fight a fire behind her Port Charlotte, FL home with water from her pool.

In 1993, a wildfire in a dry canyon north of Laguna Beach, California, raced toward hundreds of nearby homes, giving residents little advance warning of its awesome destruction. More than 14,000 acres and 440 homes went up in flames.

In the nearby Mystic Hills neighborhood, 286 homes were totally destroyed. Yet, there was one white house left standing in the midst of hundreds of piles of smoking ash that remained of its neighboring homes. This sole surviving house was built with fire prevention in mind. It stood as an example of how homes can, with a little extra attention, better withstand nature's perils. The practical methods used in and around that house can help reduce the chances of future wildfires from reducing communities to ashes. This guide is designed to make that one rare exception of survival a more common occurrence in the future.

table of contents

Introduction	1
Wildfires and Your Home	2
The Wildland/Urban Interface Problem.....	2
You and Your Local Fire Department.....	2
Just the Right Conditions.....	3
How Your Home Catches Fire.....	4
Taking Inventory - Is your property at risk?	4
What's Your Risk Level?	5
What You Can Do to Reduce Your Risk.....	5
Your Home's Landscape	7
Creating a Survivable Space.....	7
The Importance of Maintenance.....	7
Your Home's Building Materials and Design	8
The Ideal Fire-Resistant Home	8
Taking Inventory	8
Taking Action.....	9
Helping Your Local Fire Department	12
Wildfire Safety Project List	13
Wildfire Protection Checklist	14
References	19
Additional Sources of Information	20

Large Fire Locations

January 1 to October 3, 2000



*Courtesy National Interagency Fire Center
Boise, Idaho*

introduction

Nearly every state has been devastated by wildfires in the last century. More than 140,000 wildfires occur on average each year. Since 1990, more than 900 homes have been destroyed each year by wildfires.

So, what can you do to protect yourself, your home and property from wildfires? This guide will help you understand

- why your home is at risk, and
- how you can reduce the risk to your home and property.



*Bitterroot National Forest, Montana
John McColgan
FairBanks, AK • August 6, 2000*

wildfires and your home

The Wildland/Urban Interface Problem

Wildfires occur regularly. Whether started by humans or by lightning, they are part of a natural cycle that helps to maintain the health of our forests. Today, more than ever, people are moving into remote areas, with the desire to "get back to nature," without addressing the dangers that exist around them.

A tremendous wildfire danger exists where homes blend together with the wildland, creating the wildland/urban interface. The addition of homes there interrupts the natural cycle of wildfires. Ultimately,

this contributes to a dangerous build-up of old vegetation, leading to an uncontrollable wildfire.

You and Your Local Fire Department

In a wildfire, your local fire department has two priorities – to remove you and your family from harm's way and to stop the progression of the wildfire. If your home happens to be in the wildfire's path, they may or may not be able to protect it – there are simply no guarantees.

Consequently, you must take action before a fire starts.



© J Smalley, NJ • Pine Barrens

Just the Right Conditions

Conditions must be just right for a wildfire to start and spread. Specifically, fuel, weather and topography work together to determine how quickly a wildfire travels and at what intensity.

Fuels: The two basic fuel types in the wildland/urban interface are vegetation and structures.

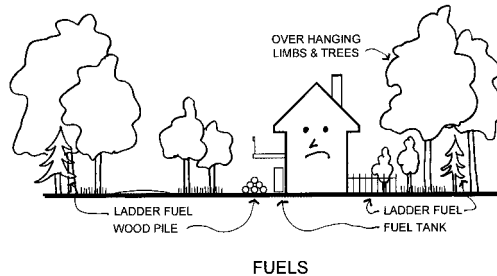

Vegetation: Fuel in its natural form consists of living and dead trees, bushes and grasses. Typically, grasses burn more quickly and with less intensity than trees. Any branches or shrubs between 18 inches and 6 feet are considered to be ladder fuels. Ladder fuels help convert a ground fire to a crown fire (tree tops) which moves much more quickly.

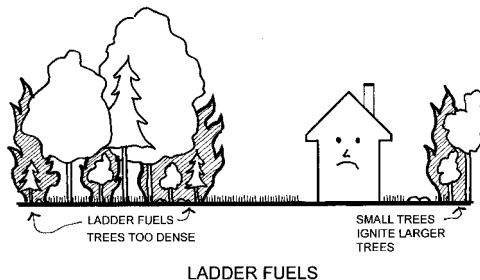

Structural Density: The closer the homes are together, the easier it is for the flames to spread from one structure to another.

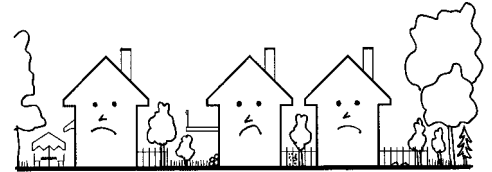

STRUCTURAL DENSITY

Weather: High temperatures, low humidity, and swift winds increase the probability of ignitions and difficulty of control. Short and long-term drought further exacerbates the problem.

Slope: Slope is the upward or downward incline or slant of terrain. For example, a completely flat plain represents a 0% slope and a hillside that rises 30 feet for every 100 feet horizontal distance represents a 30% slope.

Hot gases rise in front of the fire along the slope face, pre-heating the up-slope vegetation, moving a grass fire up to four times faster with flames twice as long as a fire on level ground.

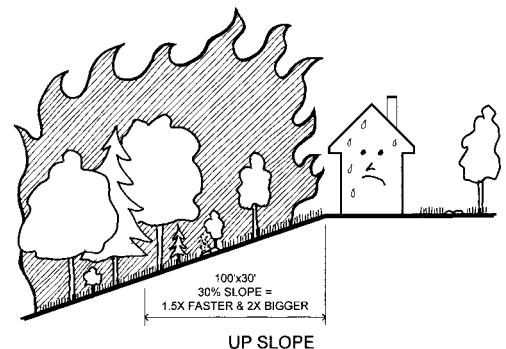

How Your Home Catches Fire

There are three ways that the wildfire can transfer itself from the natural vegetation or other burning homes to your home – through radiation, convection or firebrands.

Radiation: Wildfires can spread to your home by radiating heat in the same way a radiator heats your rooms in the wintertime. Radiated heat is capable of igniting combustible materials from distances of 100 feet or more.

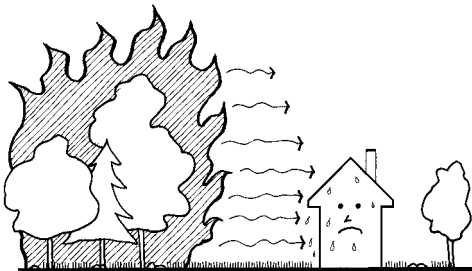

RADIATION

Convection: Contact with the convection column (flames) may also cause the wildfire to ignite your house. Typically, the convec-

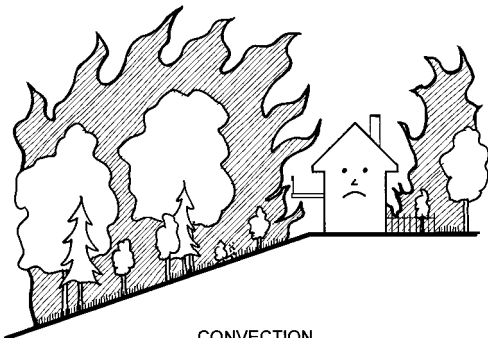

CONVECTION

tive heat column rises vertically, within the smoke plume.

Firebrands: Firebrands are burning materials that detach from a fire during strong convection drafts in the burning zone. Firebrands can be carried long distances – more than a mile – by the winds associated with the wildfire.



FIREBRANDS

In all cases, your home's building materials and design play a significant role in establishing the level of exposure that can be endured before ignition from radiation, convection, firebrands or any combination of these three.

Taking Inventory – Is Your Property at Risk?

The first step in establishing your risk is to assess your property. The table on page 5 lists numerous factors and issues that you should consider.

This assessment will give you a good sense of your property's wildfire risk.

Assessing Your Property

- | | |
|--|--|
| <input type="checkbox"/> Have wildfires occurred in your area? If so, under what conditions? | <input type="checkbox"/> Is there a substantial amount of tall vegetation crowded in around your home? |
| <input type="checkbox"/> Do you have seasons when wildfires are more likely to occur? | <input type="checkbox"/> Do tree limbs extend over your home? |
| <input type="checkbox"/> Do you live in hilly or flat country? | <input type="checkbox"/> Are the trees in good condition or are they dying? |
| <input type="checkbox"/> Are there areas around your home that are more susceptible to a wildfire? | <input type="checkbox"/> Do you have a woodpile in close proximity to your home? |
| <input type="checkbox"/> Do you border wildland? | <input type="checkbox"/> Do you have any fuel tanks nearby? |
| <input type="checkbox"/> Have you used native vegetation in your landscaping? | <input type="checkbox"/> Is a wood fence attached to your home? |

What's Your Risk Level?

The rough categories that follow on page 6 are not meant to give you an absolute score, but are to help guide you when deciding how to best protect your home.

What You Can Do To Reduce Your Risk

Homes in a wildland/urban interface area can be designed and maintained to increase the chances of surviving a wildfire without the intervention of the fire department.

This guide will help you protect your home on two different fronts:

- Your Home's Landscape
- Your Home's Building Materials and Design

Low Risk Areas:

- Little or no history of nearby wildfires
- Humid climate, short dry season
- Flat terrain (no grades greater than 9%)
- Limited wildland
- Home not crowded by trees
- Landscape includes native vegetation
- Manmade fuels at least 50 feet from your home.
- Fire hydrant within 300 feet
- Easy access for fire trucks

Moderate Risk Areas:

- History of wildfires
- Climate includes a dry season less than 3 months
- Hilly terrain (grades average between 10% and 20%)
- Bordering a wildland with light brush, small trees or grass
- Trees are located in close proximity to your home
- Native vegetation has or has not been incorporated into your landscape
- Manmade fuels are within 50 feet of your home
- Fire hydrant within 500 feet
- Access for fire trucks

High Risk Areas:

- History of nearby wildfires
- Dry climate with a dry season more than 3 months
- Steep terrain (grades average over 20%)
- Forested wildland within 100 feet of your home
- Native vegetation has not been incorporated into your landscape
- Trees are crowded within 30 feet of your home
- Manmade fuels within 30 feet of your home
- No fire hydrants
- Limited access for fire trucks

your home's landscape

Creating a Survivable Space For Your Home

A survivable space is an area of reduced fuels between your home and the untouched wildland. This provides enough distance between the home and a wildfire to ensure that the home can survive without extensive effort from either you or the fire department.

One of the easiest ways to establish a survivable space is to use the zone concept. Zone 1 is the closest to your home and Zones 2 and 3 move progressively further away.

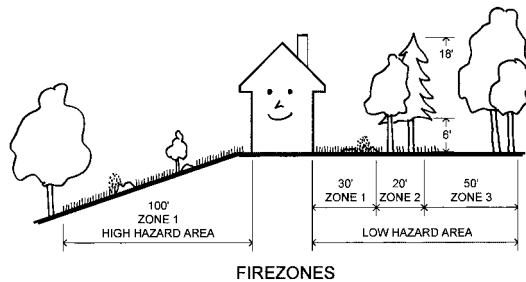

Zone 1: Establish a well-irrigated area around your home. In a low hazard area, it should extend a minimum of 30 feet from your home on all sides. As your hazard risk increases, a clearance of between 50 and 100 feet or more may be necessary, especially on any downhill sides of the lot. Plantings should be limited to carefully spaced indigenous species.

Zone 2 Place low-growing plants, shrubs and carefully spaced trees in this area. Maintain a reduced amount of vegetation. Your irrigation system

should also extend into this area.

Trees should be at least 10 feet apart, and all dead or dying limbs should be trimmed. For trees taller than 18 feet, prune lower branches within six feet of the ground. No tree limbs should come within 10 feet of your home.

Zone 3: This furthest zone from your home is a slightly modified natural area. Thin selected trees and remove highly flammable vegetation such as dead or dying trees and shrubs.

So how far should Zones 2 and 3 extend? Well, that depends upon your risk and your property's boundaries.

In a low hazard area, these two zones should extend another 20 feet or so beyond the 30 feet in Zone 1. This creates a modified landscape of over 50 feet total.

In a moderate hazard area, these two zones should extend at least another 50 feet beyond the 50 feet in Zone 1. This would create a modified landscape of over 100 feet total.

In a high hazard area, these two zones should extend at least another 100 feet beyond the 100 feet in Zone 1. This would create a modified landscape of over 200 feet total.

The Importance of Maintenance

Once you have created your home's survivable space, you must maintain it or risk losing the benefit of its protection.

your home's building materials and design

Creating and maintaining a survivable space is a necessary first step. The next step is to use fire resistant building materials and construction techniques in retrofitting your home.

The Ideal Fire-Resistant Home

Keep in mind that a wildfire sees your home as just another fuel

source. The survivable space you construct around your home will keep all but the most ferocious wildfires at bay. However, if the wildfire does break through your first line of defense, an ignition might occur on your home's exterior. The ideal situation is for your home's exterior materials to prevent or retard the flames from burning into your interior walls, soffits, attic area, and rooms.

Taking Inventory

Examine your home's construction and materials. Use the following as a checklist.

- What type of roof covering do you have? Asphalt, wood, concrete, tile or metal?
- How are your eaves, fascias and soffits constructed? Are they made from vinyl, wood or metal?
- What are your home's exterior walls covered with? Are they wood, aluminum or vinyl siding, stucco, brick or concrete masonry?
- Do you have large windows or sliding glass doors that border or face the wildland? Are they single pane, double pane or tempered glass?
- How are your home's attic and sub-floor vents protected? Are their covers metal or vinyl?
- Are spark arresters installed on all your home's chimneys?
- Does your home have a deck or balcony that overhangs a slope?
- Is there a porch, garage or wood fence that attaches directly to your home?

Taking Action

Now you will need to decide on the best modifications for your home, given your risk.

Roof: The roof is the most vulnerable part of your home to wildfires. During a wildfire, firebrands can fall on your roof, landing in your roof's nooks and crannies where a fire can easily start. Once your roof covering does ignite, chances are very good that the rest of your home will follow.

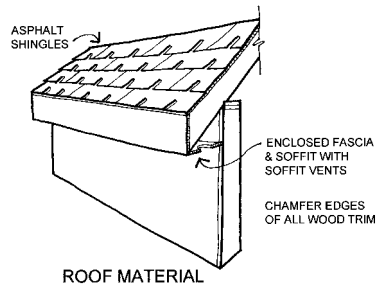
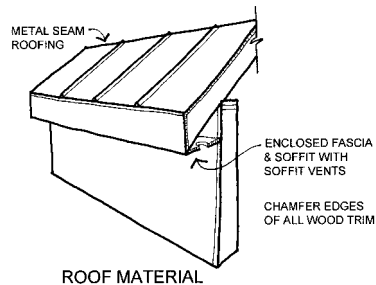

The best way to avoid this situation is to make sure your roof is fire-resistant. The two main fire resistance tests used today include: ASTM E108 and UL 790. There are three levels of classification awarded under the test protocol, A, B, and C, with A being the most

fire resistant. Some treated wood shake shingle products have ratings of Class C or better. Over time, the effectiveness of this chemical is reduced by weathering before the end of the product's useful life and may leave your roof unprotected.

If your roof needs to be re-covered, consider installing a Class A roof covering.

Exterior Walls: Exterior walls are susceptible to a wildfire's radiant and convective heat. Although a fire on an exterior wall may not penetrate inside your home, the fire can 'bridge' to more vulnerable areas such as eaves, soffits, vents and windows.

Wall materials that resist heat and flames include cement, plaster, stucco and concrete masonry such as stone, brick or block. Though some materials will not burn, such as vinyl, they may lose their integrity when exposed to high temperature and fall away or melt, providing the fire with a direct path inside the home.

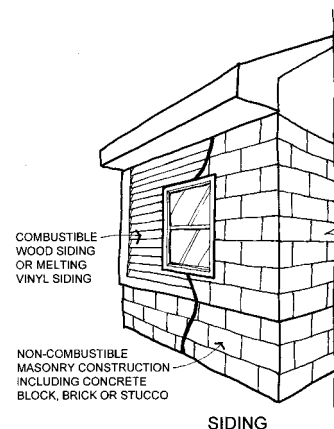

Exterior Windows, Glass Doors and Skylights: Exposure to the heat of the wildfire can cause glass to fracture and collapse, leaving an opening for flames and firebrands to enter your home. This applies to both double pane and single pane glass, since double pane glass is only slightly more resistant to heat than single pane glass.

On the other hand, single or double pane tempered glass windows, doors and skylights typically fracture at higher exposures, well above the radiant heat exposures capable of igniting the surrounding wood.

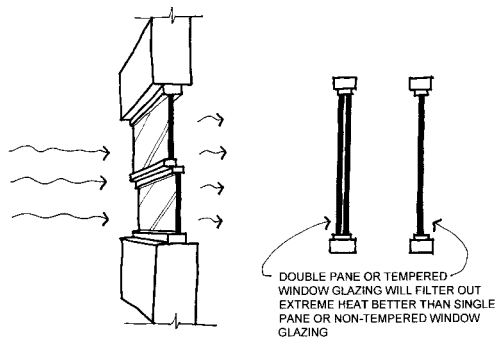

WINDOW GLAZING

Eaves, Fascias, Soffits: Eaves, fascias and soffits are vulnerable to both firebrands and convective exposures.

Eaves, fascias and soffits should be ‘boxed’ or enclosed with noncombustible materials to reduce the size of the vents. Materials that melt or

burn in relatively low temperatures, such as PVC and vinyl siding, should not be used, since they do not provide adequate protection and can melt in the heat of the wildfire. Non-combustible screening should be used in the vents.

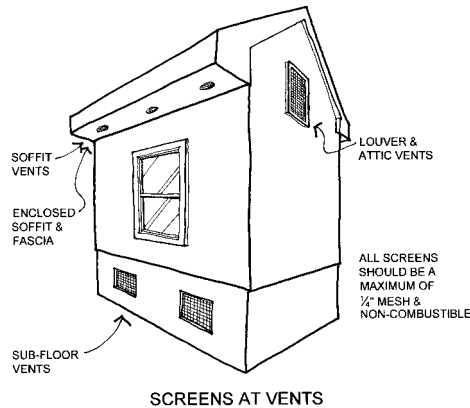

Attic, Subfloor or Foundation Vents: Wind and/or direct contact with a fire’s convective heat can push firebrands through the vents into your home’s basement or crawl space.

Your vent openings should be screened to prevent firebrands or other objects larger than 1/4 inch from entering your home. Both your vents and screens should be constructed of materials that will not burn or melt when exposed to radiate or convective heat or firebrands. Also, these vents should be corrosion-resistant to help minimize required maintenance.

Fireplace Chimneys: Windblown embers can access your home through your fireplace's chimney flue. Once inside, these firebrands then collect on flammable objects, greatly increasing the chance of combustion. The situation can also be reversed: embers from your own fire can fly out the chimney and start a wildfire, right in your own neighborhood.

The best way to avoid this situation is to install a spark arrestor made from welded wire or woven wire mesh with openings less than 1/4" wide.

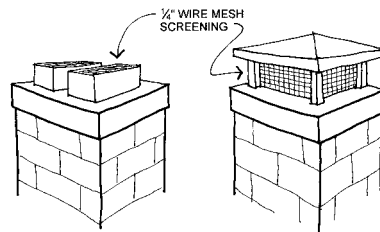

CHIMNEY SCREENS

Overhangs and Other Attachments: Overhangs and other attachments include any additional structures attached to a residence such as room pushouts, bay windows, decks, porches, carports and fences. These features are often very vulnerable to convective exposures.

When assessing your home and property, if the feature in question is attached to your home, it should be considered part of your home.

There are a number of ways you can reduce the vulnerability of your home's overhangs and attachments. First and foremost, remove all fuels around these areas. Next, box in the undersides of the overhangs, decks and balconies with noncombustible or fire-resistant materials to reduce the possibility of ignition. For fences, make sure that they don't attach directly to your home.

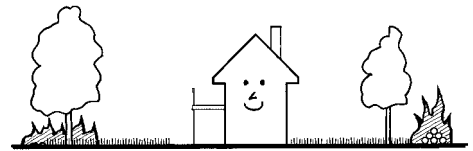

WOOD PILES, DECKS, FENCES, ETC.

helping your local fire department

Even if you modify your home's landscape to incorporate the most fire-resistant materials and design into your home's construction, there is no guarantee that a wildfire will not threaten your home. It is important that your local fire department be able to find and defend your home.

Here are some suggestions on how to modify your property to accommodate your local fire department.

Street Signs and Numbers: If made from combustible materials, your street signs and numbers can ignite or melt, leaving the fire department with no ability to locate your home. It is critical that signs and numbers be noncombustible and visible from the road.

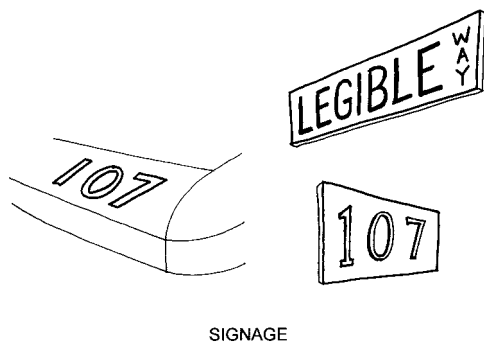

Driveways: Fire trucks and equipment are quite large and often have difficulty in tight spots. Consequently, your home's driveway must be large enough to accommodate the typical sized trucks. Fire experts recommend a driveway at least 12 feet wide and 13 feet of vertical clearance.

Gates: If your home is gated, it is very important that the gate opens inward and be wide enough to accommodate the fire fighting equipment. Experts also recommend that the gate be at least 30 feet off of the main road, so that the equipment can pull off the road to open the gate. If the gate is locked, the lock should not be so strong that firefighters cannot break it in an emergency.

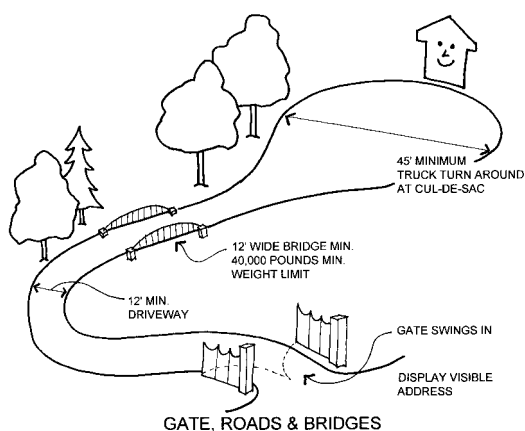

wildfire safety project list

This list of home improvements is divided into cost categories. You can tackle these projects one at a time, but remember, the more you do, the better protected your home will be against wildfires.

Category \$ (<\$300)

- Creating a survivable space;
- Maintaining your survivable space;
- Installing fire-resistant signs and address numbers;
- Modifying your attic, sub-floor, and basement vents;
- Installing a spark arrestor on your chimney.

Category \$\$ (\$300 – \$1000)

- Boxing in overhangs and modifying other attachments;
- Boxing in your eaves, facias, and soffits.

Category \$\$\$ (>\$1000)







- Re-covering your exterior walls with a more fire-resistant material;
- Replacing single-pane glass windows, doors, or skylights with tempered glass;
- Modifying your driveway, bridges, and gates to accommodate fire trucks.
- Re-roofing your home with a Class A roof covering.

WILDFIRE PROTECTION CHECKLIST











Before, During and After: Be Completely Prepared

You will give yourself and your family a better chance of escaping harm during a wildfire by taking as many of the precautions outlined in this brochure as possible. But, these steps are only the beginning. To protect yourself as completely as possible, here are some added suggestions:











before a wildfire strikes:

	Know where your gas, electric and water main shut-off controls are and how to turn them off if there is a leak or electrical short. Also, know how to use a fire extinguisher. Make sure all adult and teenage members of your family know how to shut off each utility and to use the extinguisher.
	Become familiar with your community's disaster-preparedness plans and create a family plan. Know where the closest police, fire and emergency medical facilities are located.
	Plan several different escape routes from your home and neighborhood and designate an emergency meeting place for the family to reunite. Establish a contact point to communicate with concerned relatives.
	Put together an emergency kit that includes at least a three-day supply of drinking water and food that needs no refrigeration and, generally, no cooking; emergency cooking equipment, if required; a portable NOAA weather radio; first aid supplies and medications; basic tools, such as a wrench, a flashlight and gloves; portable lanterns and batteries; credit cards and cash; and important documents, including insurance policies.
	Talk to your neighbors about wildfire safety. Plan how the neighborhood could work together before, during and after a wildfire. Make a list of your neighbors' skills such as medical or technical. Consider how you would help neighbors who have special needs such as elderly or disabled persons. Make plans to take care of children who may be on their own if parents can't get home.
	Periodically review your homeowner's insurance policy with your insurance agent or company to make sure that, if you are the victim of a disaster, you have enough coverage to rebuild your home and life.





during a wildfire:

	If you are warned that a wildfire is threatening your area, listen to your portable radio for reports and evacuation information. Follow the instructions of local officials.
	Back your car into the garage or park it in an open space facing the direction of escape. Shut car doors and roll up windows. Leave the key in the ignition or in another easily accessible location.
	Close garage windows and doors, but leave them unlocked. Disconnect automatic garage door openers.
	Confine pets to one room. Make plans to care for your pets in case you must evacuate.
	Arrange temporary housing outside the threatened area.
	When advised to evacuate, do so immediately.
	Wear protective clothing – sturdy shoes, cotton or woolen clothing, long pants, a long-sleeved shirt, gloves and a handkerchief to protect your face.
	Take your emergency kit.
	Lock your home.
	Notify your relatives and the local officials that you have left and where you can be reached.
	Follow the evacuation route that your local officials have identified. If no official route exists, choose a route away from fire hazards. Watch for changes in the speed and direction of the fire and smoke.

If you are SURE you have the time, take additional steps to protect your home:

	Close windows, vents, doors, venetian blinds and heavy drapes. Remove lightweight curtains.
	Shut off gas at the meter. Turn off pilot lights.
	Move flammable furniture into the center of the home away from windows and sliding-glass doors.
	Turn on a light in each room to increase the visibility of your home in heavy smoke.
	Seal attic and ground vents.
	Turn off propane tanks.
	Place combustible patio furniture inside.
	Connect the garden hose to outside taps.
	Place lawn sprinklers on the roof and near aboveground fuel tanks. Wet the roof.
	Wet or remove shrubs within 15 feet of the home.
	Gather fire tools, including a rake, axe, hand/chainsaw, bucket and shovel.

after a wildfire strikes:

	Listen to and follow the advice and recommendations of the local aid organizations, including the emergency management office, the fire department and the utility companies.
	Check for hazards, such as gas or water leaks and electrical shorts. Turn off damaged utilities. Have the fire department or gas and electric companies turn the utilities back on when the area is secured.
	Check for injuries and administer first aid as needed.
	Check your food and water supplies. Do not eat anything from open containers near shattered glass.

references

American Society for Testing and Materials. Standard Test Methods for Fire Testing of Roof Coverings ASTM E108. West Conshohocken, PA: ASTM, 2000.

Insurance Services Office, Inc. The Wildland/Urban Fire Hazard. New York, NY: ISO, 1997

International Fire Code Institute Urban-Wildland Interface Code. Whittier, CA: IFCI, 2000

National Fire Protection Association Firewise Landscaping Videotapes (3) and Checklist. Firewise Construction Videotapes and Checklist. Quincy, MA: NFPA, 1994

- Protecting Your Home from Wildfire. Quincy, MA: NFPA, 1987

- Standard for Protection of Life and Property from Wildfire NFPA 299. 1997 Edition. Quincy, MA: NFPA, 1997.

NFPA Journal Wildland/Urban Interface Fires. Quincy, MA: NFPA, March/April.

National Wildland/Urban Interface Fire Protection Program. Wildland/Urban Interface Fire Hazard Assessment Methodology. Washington, DC: 1997

Underwriters Laboratories Tests for Fire Resistance of Roof Covering Materials. UL 790. Northbrook, IL: 1997

Alberta Environment Land and Forest Service FireSmart: Protecting Your Community from Wildfire. Partners in Protection. Edmonton, Alberta: May 1999.

appendix I: additional sources of information

California Department of Forestry and Fire Protection (CDF)

<http://www.fire.ca.gov/>

Colorado State University/Colorado Forestry Service

<http://lamar.colostate.edu/~firewise/>

Firewise

<http://www.firewise.org/>

National Interagency Fire Center (NIFC)

<http://www.nifc.gov/>

U.S. Forest Service

<http://www.fs.fed.us/fire/>

Wildfire News

<http://www.wildfirenews.com/>



1408 North Westshore Blvd., Suite 208, Tampa, FL 33607
1 (866) 657-IBHS(4247) • Fax (813) 286-9960 • <http://www.ibhs.org/>



Fuelbreak Guidelines for Forested Subdivisions & Communities

By

Frank C. Dennis



Knowledge to Go Places

This publication was developed for use by foresters, planners, developers, homeowners' associations and others. Implementation of these measures cannot *guarantee* safety from all wildfires, but will greatly increase the probability of containing them at more manageable levels.



Inadequate fire planning can result in loss of life or property and costly suppression activities.



Colorado's forested lands are experiencing severe impacts from continuing population increases and peoples' desire to escape urban pressures. Subdivisions and developments are opening new areas for homesite construction at an alarming rate, especially along the Front Range and around recreational areas such as Dillon, Vail, and Steamboat Springs.

But with development inevitably comes a higher risk of wildfire as well as an ever-increasing potential for loss of life and property. Methods of fire suppression, pre-suppression needs, and homeowner and fire crew safety must all be considered in the planning and review of new developments as well as for the "retrofitting" of existing, older subdivisions.

Fuelbreaks should be considered in fire management planning for subdivisions and developments; however, the following are guidelines **only**. They should be customized to local areas by professional foresters experienced in Rocky Mountain wildfire behavior and suppression tactics.

Fuelbreak vs Firebreak

Although the term fuelbreak is widely used in Colorado, it is often confused with firebreak. The two are entirely separate, and aesthetically different, forms of forest fuel modification and treatment.

- A firebreak is strip of land, 20 to 30 feet wide (or more), in which all vegetation is removed down to bare, mineral soil each year prior to fire season.

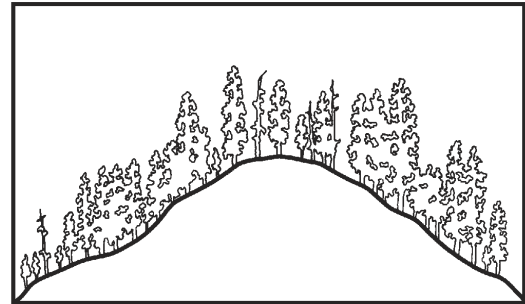

Above, cross section of mixed conifer stand before fuelbreak modification. Below, after modification.

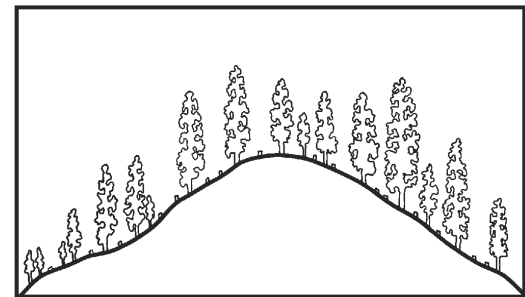

- A fuelbreak (or shaded fuelbreak) is an easily accessible strip of land of varying width (depending on fuel and terrain), in which fuel density is reduced, thus improving fire control opportunities. The stand is thinned, and remaining trees are pruned to remove ladder fuels. Brush, heavy ground fuels, snags, and dead trees are disposed of and an open, park-like appearance is established.

The following is a discussion of the uses, limitations, and specifications of fuelbreaks in wildfire control and fuels management.

Fuelbreak Limitations

Fuelbreaks provide quick access for wildfire suppression. Control activities can be conducted more safely due to low fuel volumes. Strategically located, they break up large, continuous tracts of dense timber, thus limiting uncontrolled spread of wildfire.

Fuelbreaks can aid firefighters greatly by slowing fire spread under normal burning conditions. However, under extreme conditions, even the best fuelbreaks stand little chance of arresting a large



Before and after photos of a forest stand thinned to reduce fuel loads.

fire, regardless of firefighting efforts. Such fires, in a phenomenon called “spotting,” can drop firebrands 1/8-mile or more ahead of the main fire, causing very rapid fire spread. These types of large fires may continue until there is a major change in weather conditions, topography, or fuel type.

It is critical to understand: A fuelbreak is the line of defense. The area (including any homes and developments) between it and the fire may remain vulnerable.

In spite of these somewhat gloomy limitations, fuelbreaks have proven themselves effective in Colorado. During the 1980 Crystal Lakes Subdivision Fire near Fort Collins, crown fires were stopped in areas with fuelbreak thinnings, while other areas of dense lodgepole pine burned completely. A fire at O’Fallon Park in Jefferson County was successfully stopped and controlled at a fuelbreak. The Buffalo Creek Fire in Jefferson County (1996) and the High Meadow Fire in Park and Jefferson Counties (2000) slowed dramatically wherever intense forest thinnings had been completed. During the 2002 Hayman Fire, Denver Water’s entire complex of offices, shops and caretakers’ homes at Cheesman Reservoir were saved by a fuelbreak with no firefighting intervention by a fuelbreak.



Burned area near Cheesman Reservoir as a result of the Hayman Fire. Note the unburned green trees in the middle right of the photo, a treated fuelbreak.

The Need For A Fuelbreak

Several factors determine the need for fuelbreaks in forested subdivisions, including: (1) potential problem indicators; (2) wildfire hazard areas; (3) slope; (4) topography; (5) crowning potential; and (6) ignition sources.

Potential Problem Indicator

The table below explains potential problem indicators for various hazards and characteristics common to Colorado’s forest types. All major forest types, except aspen, indicate a high potential for wildfire hazard.

Fuel Type	Characteristics			Hazards			
	Aesthetics	Wildlife	Soil	Wildfire	Avalanche	Flood	Climate
Aspen	2	3	3	2	4	3	2
Douglas-fir	2	2	3	5	2	2	3
Greasewood-Saltbrush	4	2	2	2	1	3	3
Limber-Bristlecone Pine	3	2	4	3	4	2	5
Lodgepole Pine	2	2	3	5	4	2	4
Meadow	5	4	4	2	3	4	3
Mixed Conifer	2	1	1	5	3	1	3
Mountain Grassland	5	3	4	3	3	2	4
Mountain Shrub	3	5	4	4	2	2	3
Piñon-Juniper	2	3	4	4	2	3	2
Ponderosa Pine	2	3	1	5	2	2	3
Sagebrush	4	4	3	3	3	2	3
Spruce-Fir	2	3	3	4	5	3	4

Legend: 5 – Problem may be crucial; 4 – Problem very likely; 3 – Exercise caution; 2 – Problem usually limited; 1 – No rating possible

Wildfire Hazard Maps

The Colorado State Forest Service (CSFS), numerous counties and some National Forests have completed wildfire hazard mapping for many areas within Colorado, particularly along the Front Range. These maps typically consider areas with 30 percent or greater slope; hazardous fuel types; and hazardous topographic features such as fire chimneys. Wildfire Hazard Ratings may be depicted in several ways. Whatever system is used, areas rated moderate or higher should be considered for fuel modification work.

Slope

Rate of fire spread increases as the slope of the land increases. Fuels are preheated by the rising smoke column or they may even come into contact with the flames themselves.

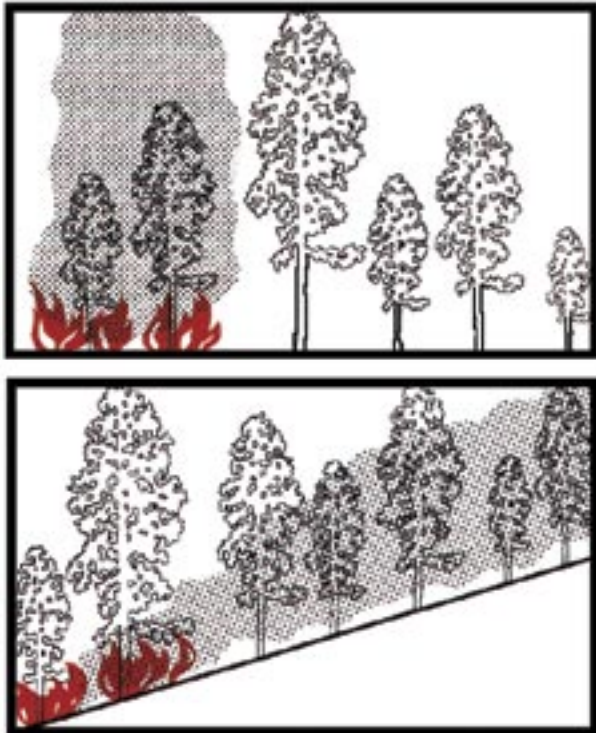

Fire effects, flat vs steep terrain. Note preheating of fuels on steep ground from passage of smoke column.

At 30 percent slope, rate of fire spread doubles compared to rates at level ground, drastically reducing firefighting effectiveness. **Areas near 30 percent or greater slopes are critical and must be reviewed carefully.**

Topography

Certain topographic features influence fire spread and should be evaluated. Included are fire chimneys, saddles, and V-shaped canyons. They are usually recognized by reviewing standard U.S.G.S. quad maps.

- Chimneys are densely vegetated drainages on slopes greater than 30 percent. Wind, as well as air pre-heated by a fire, tends to funnel up these drainages, rapidly spreading fire upslope.

- Saddles are low points along a main ridge or between two high points. Like chimneys, they also funnel winds to create a natural fire path during a fire's uphill run. Saddles act as corridors to spread fire into adjacent valleys or drainages.



Chimney.



Saddle.

- Narrow, V-shaped valleys or canyons can ignite easily due to heat radiating from one side to the other. For example, a fire burning on one side of a narrow valley dries and preheats fuels on the opposite side until the fire "flashes over." The natural effect of slope on fire then takes over and fire spreads rapidly up drainage and uphill along both sides of the valley.



Flashover in V-shaped valley.

Crowning Potential

An on-site visit is required to accurately assess crowning potential. A key, below, helps determine this rating. Fuel modification is usually unnecessary if an area has a rating of 3 or less.

Crowning Potential Key

	Rating
A. Foliage present, trees living or dead — B	
B. Foliage living — C	
C. Leaves deciduous or, if evergreen, usually soft, pliant, and moist; never oily, waxy, or resinous.	0
CC. Leaves evergreen, not as above — D	
D. Foliage resinous, waxy, or oily — E	
E. Foliage dense — F	
F. Ladder fuels plentiful — G	
G. Crown closure > 75 percent	9
GG. Crown closure < 75 percent	7
FF. Ladder fuels sparse or absent — H	
H. Crown closure > 75 percent	7
HH. Crown closure < 75 percent	5
EE. Foliage open — I	
I. Ladder fuel plentiful	4
II. Ladder fuel sparse or absent	2
DD. Foliage not resinous, waxy, or oily — J	
J. Foliage dense — K	
K. Ladder fuels plentiful — L	
L. Crown closure > 75 percent	7
LL. Crown closure < 75 percent	4
KK. Ladder fuels sparse or absent — M	
M. Crown closure > 75 percent	5
MM. Crown closure < 75 percent	3
JJ. Foliage open — N	
N. Ladder fuels plentiful	3
NN. Ladder fuels sparse or absent	1
BB. Foliage dead	0

The majority of dead trees within the fuelbreak should be removed. Occasionally, large, dead trees (14 inches or larger in diameter at 4 1/2 feet above ground level) may be retained as wildlife trees. If retained, all ladder fuels must be cleared from around the tree's trunk.

Ignition Sources

Possible ignition sources, which may threaten planned or existing developments, must be investigated thoroughly. Included are other developments and homes, major roads, recreation sites, railroads, and other possible sources. These might be distant from the proposed development,

yet still able to channel fire into the area due to slope, continuous fuels, or other topographic features.

Fuelbreak Locations

In fire suppression, an effective fire line is connected, or "anchored," to natural or artificial fire barriers. Such anchor points might be rivers, creeks, large rock outcrops, wet meadows, or a less flammable timber type such as aspen. Similarly, properly designed and constructed fuelbreaks take advantage of these same barriers to eliminate "fuel bridges." (Fire often escapes control because of fuel bridges that carry the fire across control lines.)

Since fuelbreaks should normally provide quick, safer access to defensive positions, they are necessarily linked with road systems. Connected with county-specified roads within subdivisions, they provide good access and defensive positions for firefighting equipment and support vehicles. Cut-and fill slopes of roads are an integral part of a fuelbreak as they add to the effective width of modified fuels.

Fuelbreaks without an associated road system, such as those located along strategic ridge lines, are still useful in fire suppression. Here, they are often strengthened and held using aerial retardant drops until fire crews can walk in or be ferried in by helicopter.

Preferably, fuelbreaks are located along ridge tops to help arrest fires at the end of their runs. However, due to homesite locations and resource values, they can also be effective when established at the base of slopes. Mid-slope fuelbreaks are least desirable, but under certain circumstances and with modifications, these too, may be valuable.

Fuelbreaks are located so that the area under management is broken into small, manageable units. Thus, when a wildfire reaches modified fuels, defensive action is more easily taken, helping to keep the fire small. For example, a plan for a subdivision might recommend that fuelbreaks break up continuous forest fuels into units of 10 acres or less. This is an excellent plan, especially if defensible space thinning is completed around homes and structures, and thinning for forest management and forest health are combined with the fuelbreak.

When located along ridge tops, continuous length as well as width are critical elements. Extensive long-range planning is essential in positioning these types of fuelbreaks.

Aesthetics

Improperly planned fuelbreaks can adversely impact an area's aesthetic qualities. Careful construction is necessary when combining mid-slope fuelbreaks with roads involving excessive cut-and-fill.



These photos, far- and near- views of the same site, illustrate that forest can be thinned without impacting aesthetics.

Care must also be taken in areas that are not thinned throughout for fuel hazard reduction. In such cases the fuelbreak visually sticks out like a "sore thumb" due to contrasting thinned and unthinned portions of the forest. (Especially noticeable are those portions of the fuelbreak above road cuts).

These guidelines are designed to minimize aesthetic impacts. However, some situations may require extensive thinning and, thus, result in a major visual change to an area. Additional thinning beyond the fuelbreak may be necessary to create an irregular edge and to "feather," or blend, the fuelbreak thinning into the unthinned portions of the forest. Any thinning beyond the fuelbreak improves its effectiveness and is highly recommended.

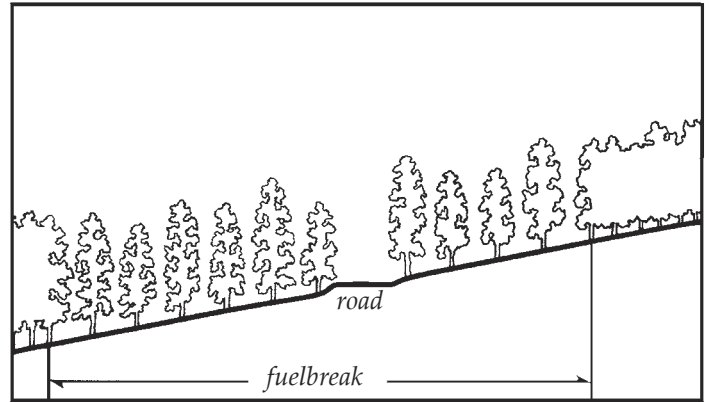

Cross-section of a typical fuelbreak built in conjunction with a road.

Constructing the Fuelbreak

Fuelbreak Width and Slope Adjustments

Note: Since road systems are so important to fuelbreak construction, the following measurements are from the toe of the fill for downslope distances, and above the edge of the cut for uphill distances.

The minimum recommended fuelbreak width is approximately 300 feet for level ground. Since fire activity intensifies as slope increases, the overall fuelbreak width must also increase. However, to minimize aesthetic impacts and to maximize fire crew safety, the majority of the increases should be made at the bottom of the fuelbreak, below the road cut.

Widths are also increased when severe topographic conditions are encountered. Guidelines for fuelbreak widths on slopes are given below:

Fuelbreak Width/Slope			
Percent Slope (%)	Minimum Uphill Distance (ft)	Minimum Downhill Distance (ft)	Total Width of Modified fuels (ft)*
0	150	150	300
10	140	165	303
20	130	180	310
30	120	195	315
40	110	210	320
50	100	225	325
60	100	240	340

*As slope increases, total distance for cut-and-fill for road construction rapidly increases, improving fuelbreak effective width.

Stand Densities

Crown separation is a more critical factor for fuelbreaks than a fixed tree density level. A *minimum* 10-foot spacing between the edges of tree crowns is recommended on level ground. As slope increases, crown spacing should also increase. However, small, isolated groups of trees may be retained for visual diversity. Increase crown spacing around any groups of trees left for aesthetic reasons and to reduce fire intensities and torching potential.

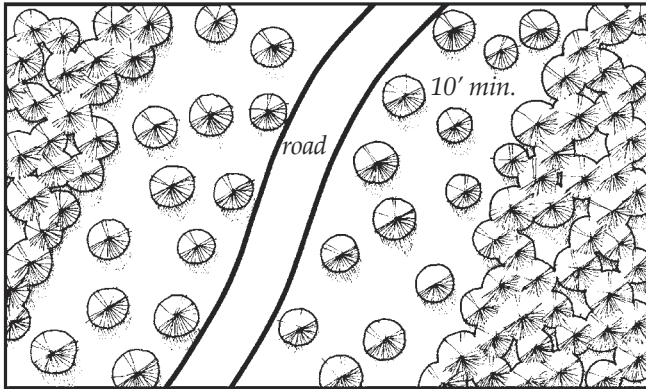

Plan view of fuelbreak showing minimum distance between tree crowns.

In technical terms, a fuelbreak thinning is classified as a heavy "sanitation and improvement cut, from below." Within fuelbreaks, trees that are suppressed, diseased, deformed, damaged, or of low vigor are removed along with all ladder fuels. Remaining trees are the largest, healthiest, most wind-firm trees from the dominant and co-dominant species of the stand.

Because such a thinning is quite heavy for an initial entry into a stand, prevailing winds, eddy effects, and wind funneling must be carefully evaluated to minimize the possibility of windthrow. It may be necessary to develop the fuelbreak over several years to allow the timber stand to "firm-up" — this especially applies to lodgepole pine and Engelmann spruce stands.

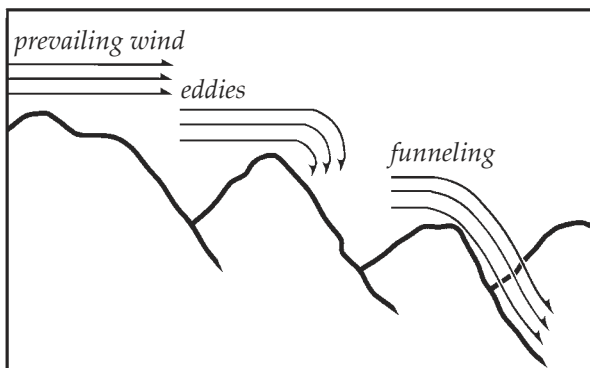

Topography affects wind behavior — an important consideration during fuelbreak construction.

Area-wide forest thinnings are recommended for any subdivisions. Such thinning is not as severe as a fuelbreak thinning, but generally should be completed to fuelbreak specifications along the roads (as outlined on page 6.) In addition, "defensible space thinnings" are highly recommended around all structures (see CSU Coop. Extension Fact sheet 6.302, *Creating Wildfire-Defensible Zones*).

Debris Removal

Limbs and branches left from thinning (slash) can add significant volumes of fuel to the forest floor, especially in lodgepole pine, mixed-conifer, or spruce/fir timber types. These materials can accumulate and serve as ladder fuels, or can become "jackpots," increasing the difficulty of defending the fuelbreak during a wildfire. **Slash decomposes very slowly in Colorado and proper disposal is essential.** Proper treatment reduces fire hazard, improves access for humans and livestock, encourages establishment of grasses and other vegetation, and improves aesthetics.

Three treatment methods are commonly used. These are lopping-and-scattering, piling and burning, and chipping. Mulching of small trees and slash using equipment similar to Hydro-axes or Timbcos equipped with mulching heads are becoming a popular method of treatment. Size, amount, and location of slash dictates the method used, in addition to cost and the final desired appearance. The method chosen will also depend on how soon an effective fuelbreak is needed prior to construction in new developments.



Lop and scatter: slash should be no deeper than 12" above ground surface.



Chipping is the most desirable, but also the most expensive method of slash disposal.



Piled slash can be burned but only during certain conditions, such as after a snowfall.

Fuelbreak Maintenance

Following initial thinning, trees continue to grow (usually at a faster rate). The increased light on the forest floor encourages heavy grass and brush growth where, in many cases, where little grew before. The site disturbance and exposed mineral soil created during fuelbreak development is a perfect seed bed for new trees that, in turn, create new ladder fuels. Thus, in the absence of maintenance, fuelbreak effectiveness will decrease over time.



Fuelbreak maintenance is essential. Ingrowth, shown above, will minimize the effectiveness of this fuelbreak within a few years.

Fuelbreak maintenance problems are most often the result of time and neglect. Misplaced records, lack of follow-up and funding, and apathy caused by a lack of fire events are some of the major obstacles. In addition, the responsibility for fuelbreak maintenance projects is often unclear. For example, control of a fuelbreak completed by a developer passes to a homeowner's association, usually with limited funds and authority to maintain fuelbreaks.

If fuelbreak maintenance is not planned and completed as scheduled, consider carefully whether the fuelbreak should be constructed. An un-maintained fuelbreak may lead to a false sense of security among residents and fire suppression personnel.

Conclusion

An image of well-designed communities for Colorado includes:

- Forested subdivisions where the total forest cover is well-managed through carefully planned, designed, and maintained thinnings. This contributes to reduced wildfire hazards and a much healthier forest — one that is more resistant to insects and disease.
- A system of roads and driveways with their associated fuelbreaks that break up the continuity of the forest cover and fuels. These help keep fires small, while also providing safer locations from which to mount fire suppression activities. In addition to allowing fire personnel in, they will allow residents to evacuate if necessary.
- Individual homes that all have defensible space around them, making them much easier to defend and protect from wildfire, while also protecting the surrounding forest from structure fires.

Creation of such communities is entirely feasible if recognition of the fire risks, a spirit of cooperation, an attitude of shared responsibility, and the political will exists.

*Colorado's mountains comprise diverse slopes, fuel types, aspects, and topographic features. This variety makes it impossible to develop general fuelbreak prescriptions for all locations. **The previous recommendations are guidelines only.** A professional forester with fire suppression expertise should be consulted to "customize" fuelbreaks for particular areas.*

Appendix G – Fuelbreaks & Prescribed Burns

No fuelbreaks or prescribed burns are recommended in this CWPP. This page is a place holder for possible future activities.

APPENDIX H – Road and Driveway Specifications for Emergency Access

Roads serving one dwelling unit shall meet the following:

- A. Roadway shall be a total of 14' in width, including a 10' all-weather travel surface and 2' shoulders (each side). Curves and turn a rounds should have a minimum of a 30' radius at centerline.
- B. Road grade should generally not be over 7 percent. A maximum grade 10 percent to 12 percent grade would be acceptable for short distances not over 150 feet.
- C. If the driveway is less than 50' the above (A and B) do not apply.
- D. If the length of the road exceeds 150', a turnaround shall meet (template 1 or 2) standards.

Roads serving more than one dwelling shall meet the following:

- A. Roadway shall be a total of 20' in width, including a 16' all weather travel surface and 2' shoulders (template 3) to 16 units, or a total width of 14', including a 10' travel surface, with 2' shoulders on either side and pullouts at 150' intervals in accordance with (template 4).
- B. A total roadway width of 24', including an 18' paved surface and 3' shoulders in accordance with (template 3) for roads serving 16 or more dwellings, or one or more non-residential units.
- C. Grades shall be the same as for one dwelling roads/driveway identified above.
- D. If the length of the driveway is less than 50' then A and B above does not apply.
- E. If the length exceeds 150', a turnaround shall be provided in accordance with (template 1 or 2).

Driveway approaches and private road intersections with public roads shall meet the following:

- A. Driveway approaches and private road intersections with public roads must comply with (template 5).

TEMPLATE 1 - Cul-de-sac

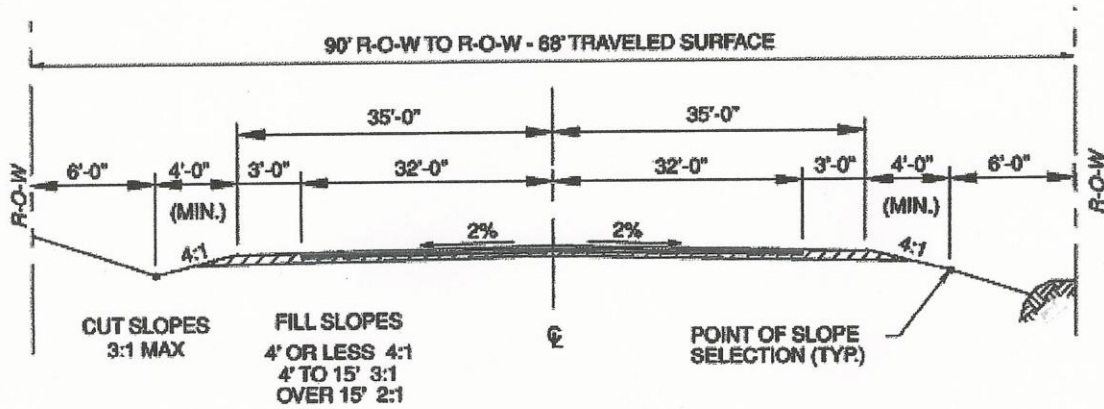
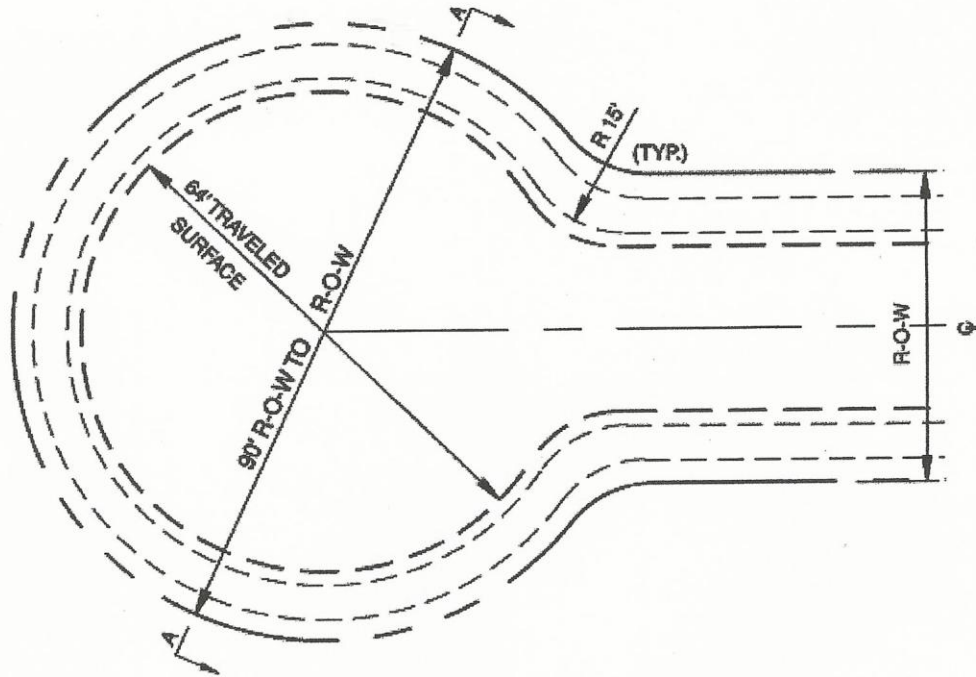

SECTION A - A

TEMPLATE 2 – Hammerhead Turnaround

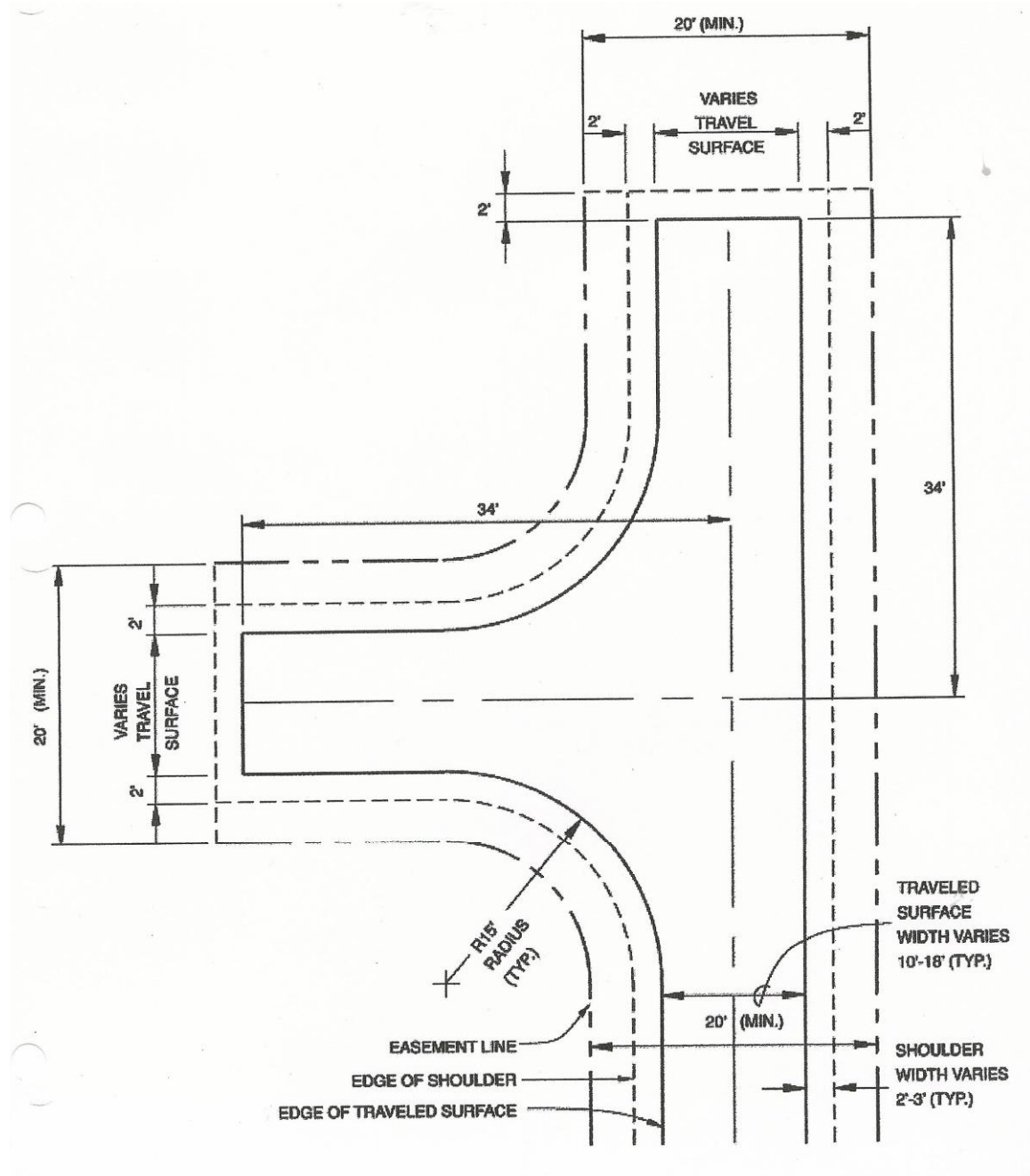

TEMPLATE 3 – Private Road

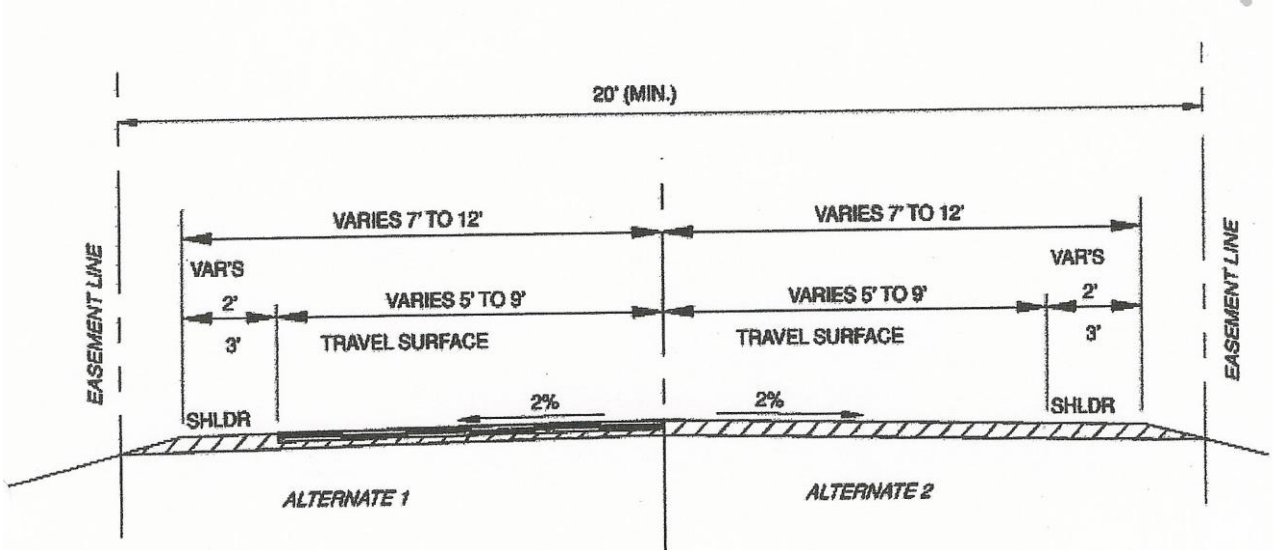

TEMPLATE 4 – Pull Out for Private Road

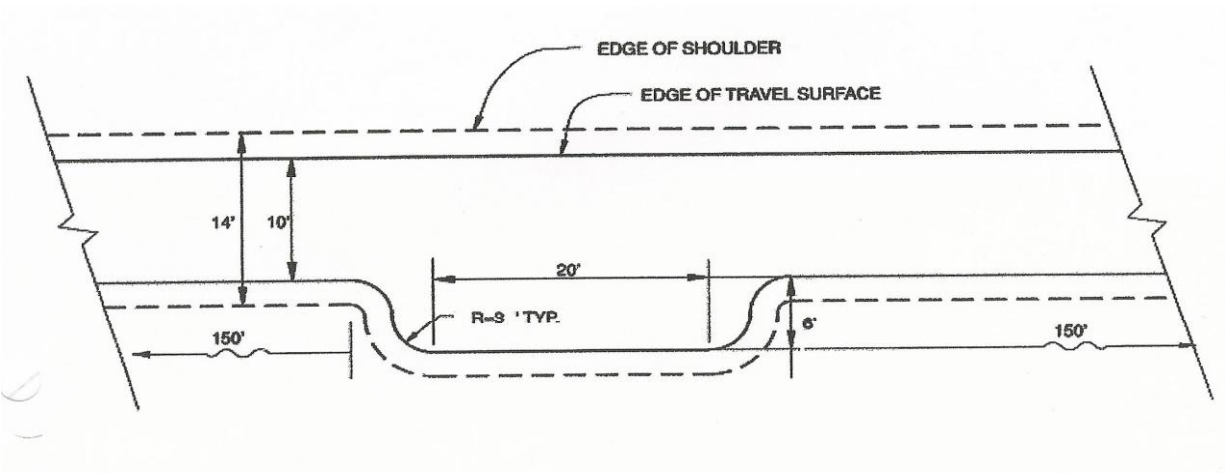

APPENDIX I – Definition of Terms

Appropriate Management Response (AMR) - Specific actions taken in response to a wildland fire to implement protection and fire use objectives identified by appropriate government agency. AMR allows for a full range of strategies to be applied, from an intense full suppression response to wildland fire use. The first response decision to be made is whether to have a suppression oriented response or to allow the fire to burn for predetermined benefits.

Confinement Response- The suppression-orientated strategy employed in appropriate management response where a fire perimeter is managed by a combination of direct and indirect actions and use of natural topographic features, fuels, and weather factors. These strategies and tactics could include perimeter control.

Defensible Space- Area around a structure where fuels and vegetation are treated, cleared or reduced to slow the spread of wildfire towards the structure. It also reduces the chance of a structure fire moving from the building to surrounding forest. Defensible space provides room for firefighters to do their jobs.

Disturbance- A discrete event, either natural or human induced, that causes a change in the existing condition of an ecological system.

Energy Release Component (ERC) - An index developed through the National Fire Danger Rating System. ERC then is an indicator of dryness in the fuel, is a fuel loading based rate that predicts how much energy f fire will produce both from its consumption of available fuel and through its residence time. ERC, and 1000 hour time lag fuel moisture has been used in dry climates to track seasonal drying trends.

Escape Fire Situation Analysis (EFSA) - If a wildfire has escaped initial attack EFSA is the process the agency administrator or acting uses to determine the best suppression strategy for achieving appropriate suppression that best meets resource objectives.

Fire Management Plan (FMP) - A strategic plan that defines a program to manage wildland and prescribed fires. The plan could be supplemented by operational plans, prescribed fire plans, hazardous fuels reduction, and prevention plans.

Fire Use - The combination of wildland fire use and prescribed fire application to meet specific resource and landowner objectives.

Fuel Treatment - Programmed and contracted to reduce or change fuel loading or type on a site. Can be accomplished by mechanical, chemical or fire use.

Full Response - A suppression response action that can include: control lines surrounding the entire perimeter, (hot spot and cold trail may be considered completed line) including any spot fires, protection of interior islands, burn-out of fuels adjacent to control lines and mop-up to a standard adequate to hold under high fire intensity conditions. Full response objectives are based on safe yet aggressive approach to achieve containment of the fire by the beginning of the next burn period. Fire behavior may dictate, at least temporarily, the utilization of natural barriers or indirect strategies. These strategies and tactics would include direct control.

Haines Index - Lower atmosphere stability index (LASI) developed by Donald Haines. The index relies on two variables: dryness and stability/instability. On a scale of six, three points are given to dryness and three to the stability or instability of the atmosphere. Both these variables have a pronounced affect on extreme fire behavior. In the scaling, a 6 is extreme, 5 are high, 4 are moderate, while 3 to 1 are low.

Home Ignition Zone – Includes an area surrounding the home within 100 to 200 feet. The potential for ignition depends on the home’s exterior materials and design and the amount of heat to the home form the flames within the home ignition zone.

Initial Attack - An aggressive suppression action consistent with firefighter and public safety and values to be protected.

Insurance Services Office (ISO) Rating - An overall fire services rating developed for use in determining insurance premiums for residential and commercial property. Factors such as fire alarm systems, equipment, training, availability of water (hydrants), etc. are used to develop the rating. The rating is on a scale of class 1 to class 10, with 1 providing the best public protection and 10 providing the lowest public protection. See www.iso.com for more details.

Mitigation Actions - Those on-the-ground activities that will serve to increase the survivability of the structure to check, direct, or delay the spread of fire, and minimize threats to life, property, and resources. Mitigation actions may include mechanical and physical non-fire tasks, specific fire applications, and limited suppression actions. These actions will be used to construct fire lines, reduce excessive fuel concentrations, reduce vertical fuel, and create black lines.

POL – Stands for “Products Other than Logs” thinning to harvest poles and posts and firewood.

Preparedness - Activities that lead to a safe, efficient, and cost-effective fire management program in support of land and owners management objectives through appropriate planning and coordination.

Prescribed Fire - Any fire ignited by management actions to meet specific objectives. A written, approved prescribed fire plan must exist prior to ignition.

Prescribed Fire Plan - A plan required for each fire application ignited by management. It must be prepared by qualified personnel and approved by the appropriate agency administrator prior to implementation. Each plan will follow specific direction and must include critical elements and how to mitigate each element.

Spread Component (SC) - An index developed through the National Fire Danger Rating System. The index provides predicted rate of spread of a fire (in chains per hour) from inputted information on the fuel complex and weather information collected from a local Remote Automated Weather System (RAWS) site.

Suppression Constraints - A limitation placed on suppression forces to minimize adverse affects to the environment due to fire suppression activities. An example would be restricting the use of heavy equipment in certain areas.

Suppression Oriented Response - A range of responses to a wildland fire, which range from full response to confinement of the fire. It may also include periodically checking fire status and fire behavior.

TSI – Stands for “Timber Stand Improvement” thinning to stimulate growth and improve residual tree health

Wildfire - An unwanted wildland fire.

Wildland Fire - Any nonstructural fire, other than prescribed fire, that occurs in the wildland. This term encompasses fires previously called both wildfires and prescribed natural fires.

Appendix J: Potential Sources of Funding

There are numerous sources to explore for funding actions identified in this CWPP. They include, but are not limited to: El Pomar Foundation, FEMA, NRCS, BLM, CSFS and many more.

BLM is still funding the WUI Community Assistance program which is intended to support fire departments, local government, communities, community service organizations and non-profits in implementing wildland fire related projects. Successful applicants are awarded project funding through a Financial Assistance Agreement under a 90:10 cost share.

The Funding Opportunity Announcement is posted on [grants.gov](https://www.grants.gov) for 60 days, usually in April or May. Typical awards have been running between \$8,000 and \$12,000.

Colorado State Forest Service maintains a couple of databases that can assist communities looking for grant opportunities to fund implementation of their CWPP. Their website has two locations that will be of interest. The “Landowner & Community Assistance Programs for Forestry & Agroforestry in Colorado” is one and the “Natural Resources Grants & Assistance Database” is the other.

There is also the:

Ready, Set, Go! Program Grants for Fire Department Fuels Mitigation

The International Association of Fire Chiefs (IAFC) and American International Group, Inc. (AIG) are pleased to offer direct funding no cost-share grants of approximately \$5,000 to help RSG members with their community fuels mitigation programs.

Scope:

RSG Fuels Mitigation Grants are intended for the purpose of establishing or enhancing a fire department’s community fuels mitigation program while educating members of the community about community wildfire readiness and encouraging personal action.

Funding can be used for a fuels mitigation trailer, equipment, chipper purchase or rental, debris disposal costs and incentives or any combination of these.

Grant Criteria:

- Applicant must be a member of the Ready, Set, Go! Program

- Application must be submitted to the IAFIC as outlined below
- Awardee is expected to record efforts funded by the grant in AMS
- Awardee must indicate whether reimbursement or advanced funding is preferred
- Awardee must assist with award delivery by submitting requested financial process documentation
- Grant funds must be used within 6 months of award

APPENDIX K – References and Publications

Anderson, Hal E. 1982. Aids to determining fuel Models for Estimating fire Behavior. USDA Forest Service. General Technical Report INT-122, 22 p. Intermountain Forest and Range Experiment Station, Utah, 84401.

Andrews, Patricia; Bevins, Collin; and Seli, Robert. BehavePlus fire modeling system User's Guide. USDA forest Service. General Technical Report RMRS- GTR-106WWW. Rocky Mountain Research Station.

Cohen Jack D. “Wildland-Urban Fire – A Different Approach”

Dennis F.C. 1999. Fire Resistant Landscaping. No. 6.303 Natural Resource Series, Colorado State University Cooperative Extension.

Dennis F.C. 1999. Forest Home fire safety. No. 6.304 Natural Resource Series, Colorado State University Cooperative Extension.

Dennis F.C. 2002. Firewise Plant Materials. No. 6.305 Natural Resource Series, Colorado State University Cooperative Extension.

Dennis F.C. 2003. Creating Wildfire-Defensible Zones. No. 6.302 Natural Resource Series, Colorado State University Cooperative Extension.

Dennis F.C. 2005. Fuelbreak Guidelines for Forested Subdivisions & Communities. Colorado State Forest Service.

Graham, Russell. 2003. Editor. Hayman Fire Case Study: summary. USDA Forest Service. General Technical Report RMRE-GTR-115. Rocky Mountain Research Station.

Helms, John. 1998. The Dictionary of Forestry. Society of American Foresters.
Troy, Austin & Kennedy, Roger. Editors. 2007 Living on the Edge, Volume 6: Economic, Institutional and Management Perspectives on Wildfire Hazard in the Urban Interface (Advances in the Economics of Environmental Resources). JAI Press - Elsevier

International Urban-Wildland Interface Code. 2003. International Code Council, INC.

Minimum Standards for Delivering Community Wildfire Protection Plans. 2009 Colorado state Forest Service.

NFPA 1144 – Standard for Protection of Life and Property from Wildfire, 2002 Edition

NFPA 295 – Standard for Wildfire Control, 1998 Edition

Preparing a Community Wildfire Protection Plan - A Handbook for Wildland-Urban Interface Communities. 2004. Society of American Foresters, Western Governors' Association et al.

Publications

- Creating Wildfire-Defensible Zones, no 6.302, F.C. Dennis, CSU Cooperative Extension, 5/2003
- Fire Resistant Landscaping, no 6.303, F.C. Dennis, CSU Cooperative Extension, 5/1999
- Forest Home Fire Safety, no 6.304, F.C. Dennis, CSU Cooperative Extension, 5/1999
- FireWise Plant Materials, no 6.305, F.C. Dennis, CSU Cooperative Extension, 11/2003
- Grass Seed Mixes to Reduce Wildfire Hazards, no 6.306, F.C. Dennis, CSU Cooperative Extension, 10/2003
- Vegetative Recovery After Wildfire, no 6.307, R. Moench, CSU Cooperative Extension, 10/2003
- Soil Erosion Control After Wildfire, no 6.308, R. Moench & J. Fusaro, CSU Cooperative Extension, 10/2003
- Insects and Diseases Associated with Forest Fires, no 6.309, D. Leatherman, CSU Cooperative Extension, 12/2002
- Fuelbreak Guidelines for Forested Subdivisions, F. C. Dennis, CSFS/CSU, 2005
- International Urban-Wildland Interface Code. 2003. International Code Council, INC.
- Minimum Standards for Delivering Community Wildfire Protection Plans. 2009 Colorado state Forest Service.
- NFPA 1144 – Standard for Protection of Life and Property from Wildfire, 2002 Edition
- NFPA 295 – Standard for Wildfire Control, 1998 Edition
- Preparing a Community Wildfire Protection Plan - A Handbook for Wildland-Urban Interface Communities. 2004. Society of American Foresters, Western Governors' Association et al.

COLORADO WILDFIRE RISK ASSESSMENT SUMMARY REPORT

*Chandler
Heights*



Report was generated using
www.ColoradoWildfireRisk.com

Report version: 4.0

Report generated: 2/15/2017

Table of Contents

Disclaimer.....	Error! Bookmark not defined.
Introduction	Error! Bookmark not defined.
Wildland Urban Interface.....	Error! Bookmark not defined.
Wildland Urban Interface (WUI) Risk Index.....	Error! Bookmark not defined.
FireWise Communities.....	Error! Bookmark not defined.
Community Wildfire Protection Plans (CWPPs).....	Error! Bookmark not defined.
Forest Management Activities.....	Error! Bookmark not defined.
Wildfire Risk.....	Error! Bookmark not defined.
Wildfire Threat.....	Error! Bookmark not defined.
Values Impacted Rating	Error! Bookmark not defined.
Suppression Difficulty Rating.....	Error! Bookmark not defined.
Fire Occurrence.....	Error! Bookmark not defined.
Fire History Statistics.....	Error! Bookmark not defined.
Fire Behavior	Error! Bookmark not defined.
Characteristic Rate of Spread	Error! Bookmark not defined.
Characteristic Flame Length	Error! Bookmark not defined.
Fire Intensity Scale.....	Error! Bookmark not defined.
Fire Type – Extreme Weather.....	Error! Bookmark not defined.
Surface Fuels.....	Error! Bookmark not defined.
Vegetation.....	Error! Bookmark not defined.
Drinking Water Importance Areas	Error! Bookmark not defined.
Drinking Water Risk Index.....	Error! Bookmark not defined.
Riparian Assets.....	Error! Bookmark not defined.
Riparian Assets Risk Index.....	Error! Bookmark not defined.
Forest Assets.....	Error! Bookmark not defined.
Forest Assets Risk Index.....	Error! Bookmark not defined.
References	Error! Bookmark not defined.

Disclaimer

Colorado State Forest Service makes no warranties or guarantees, either expressed or implied as to the completeness, accuracy, or correctness of the data portrayed in this product nor accepts any liability, arising from any incorrect, incomplete or misleading information contained therein. All information, data and databases are provided "As Is" with no warranty, expressed or implied, including but not limited to, fitness for a particular purpose.

Users should also note that property boundaries included in any product do not represent an on- the-ground survey suitable for legal, engineering, or surveying purposes. They represent only the approximate relative locations.

Introduction

Colorado Wildfire Risk Assessment Report

Welcome to the Colorado Wildfire Risk Assessment Summary Reporting Tool.

This tool allows users of the Professional Viewer application of the Colorado Wildfire Risk Assessment (Colorado WRA) web portal to define a specific project area and generate information for this area. A detailed risk summary report can be generated using a set of predefined map products developed by the Colorado Wildfire Risk Assessment project which have been summarized explicitly for the user defined project area. The report is generated in MS WORD format.

The report has been designed so that information from the report can easily be copied and pasted into other specific plans, reports, or documents depending on user needs. Examples include, but are not limited to, Community Wildfire Protection Plans, Local Fire Plans, Fuels Mitigation Plans, Hazard Mitigation Plans, Homeowner Risk Assessments, and Forest Management or Stewardship Plans. Example templates for some of these reports are available for download on the Colorado Wildfire Risk Assessment web portal (CO-WRAP).

The Colorado WRA provides a consistent, comparable set of scientific results to be used as a foundation for wildfire mitigation and prevention planning in Colorado.

Results of the assessment can be used to help prioritize areas in the state where mitigation treatments, community interaction and education, or tactical analyses might be necessary to reduce risk from wildfires.



The Colorado WRA products included in this report are designed to provide the information needed to support the following key priorities:

- Identify areas that are most prone to wildfire
- Plan and prioritize hazardous fuel treatment programs
- Allow agencies to work together to better define priorities and improve emergency response, particularly across jurisdictional boundaries
- Increase communication with local residents and the public to address community priorities and needs

Wildland Urban Interface

Description

Colorado is one of the fastest growing states in the Nation, with much of this growth occurring outside urban boundaries. This increase in population across the state will impact counties and communities that are located within the Wildland Urban Interface (WUI). The WUI is described as the area where structures and other human improvements meet and intermingle with undeveloped wildland or vegetative fuels. Population growth within the WUI substantially increases the risk from wildfire.



For the **Chandler Heights** project area, it is estimated that **81** people or **100.0 % percent** of the total project area population (81) live within the WUI.

The Wildland Urban Interface (WUI) layer reflects housing density depicting where humans and their structures meet or intermix with wildland fuels. In the past, conventional wildland-urban interface data sets, such as USFS SILVIS, have been used to reflect these concerns. However, USFS SILVIS and other existing data sources did not provide the level of detail needed by the Colorado State Forest Service and local fire protection agencies.

The new WUI data set is derived using advanced modeling techniques based on the Where People Live data set and LandScan USA population count data available from the Department of



Homeland Security, HSIP Freedom data set. WUI is simply a subset of the Where People Live data set. The primary difference is populated areas surrounded by sufficient non-burnable areas (i.e. interior urban areas) are removed from the Where People Live data set, as these areas are not expected to be directly impacted by a wildfire.

A more detailed description of the risk assessment algorithms is provided in the Colorado Wildfire Risk Assessment (Colorado WRA)

Final Report, which can be downloaded from www.ColoradoWildfireRisk.com.

Data is modeled at a 30-meter cell resolution, which is consistent with other Colorado WRA layers. The WUI classes are based on the number of houses per acre. Class breaks are based on densities understood and commonly used for fire protection planning.

Housing Density	WUI Population	Percent of WUI Population	WUI Acres	Percent of WUI Acres
Less than 1house/40ac	10	12.3 %	442	64.3 %
1house/40ac to 1house/20ac	5	6.2 %	85	12.3 %
1house/20ac to 1house/10ac	10	12.3 %	57	8.3 %
1house/10ac to 1house/5ac	33	40.7 %	74	10.7 %
1house/5ac to 1house/2ac	23	28.4 %	30	4.4 %
1house/2ac to 3house/1ac	0	0.0 %	0	0.0 %
More than 3house/1ac	0	0.0 %	0	0.0 %
Total	81	100.0 %	687	100.0 %

Chandler Heights Wildland Urban Interface

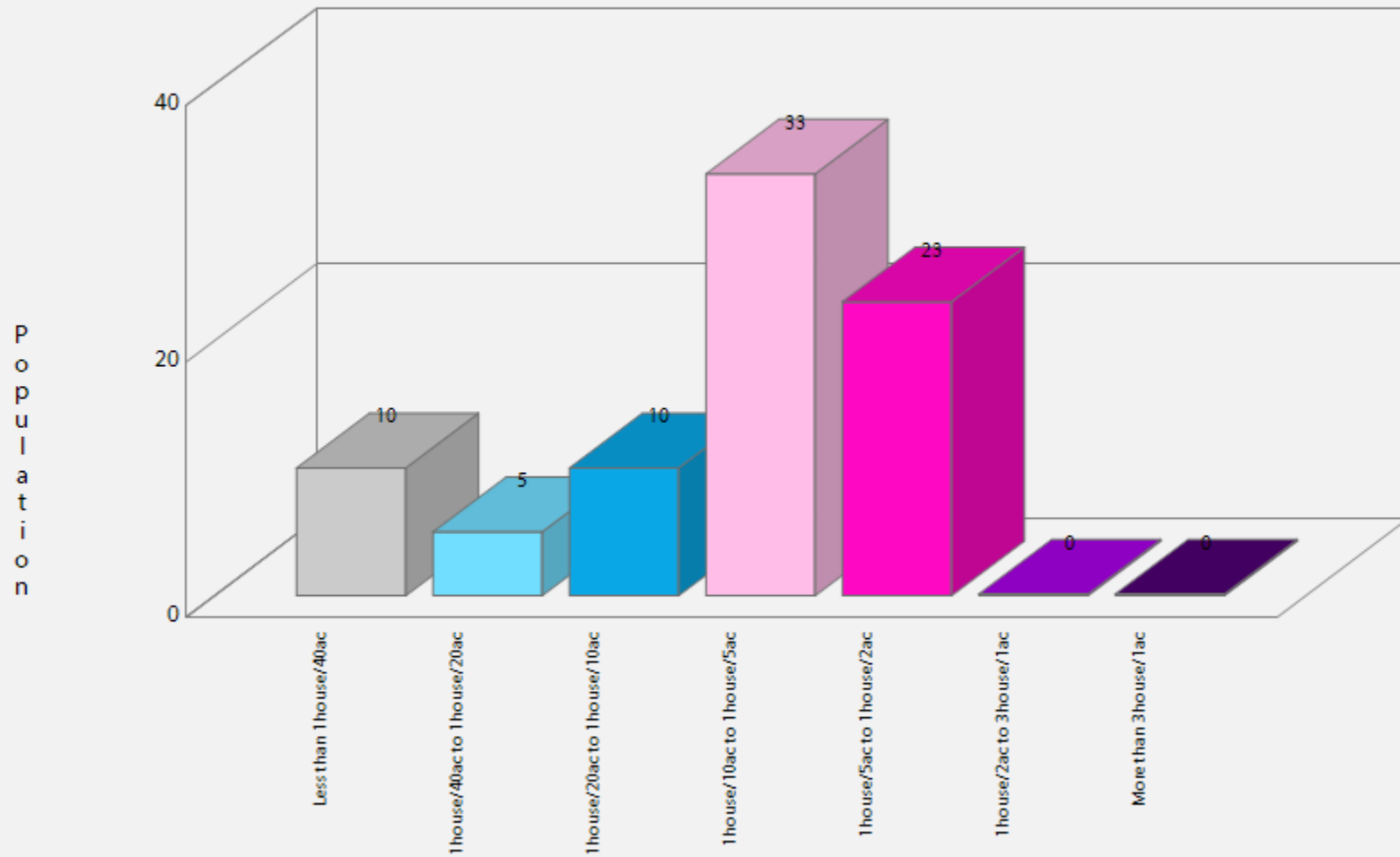

Chandler Heights Wildland Urban Interface

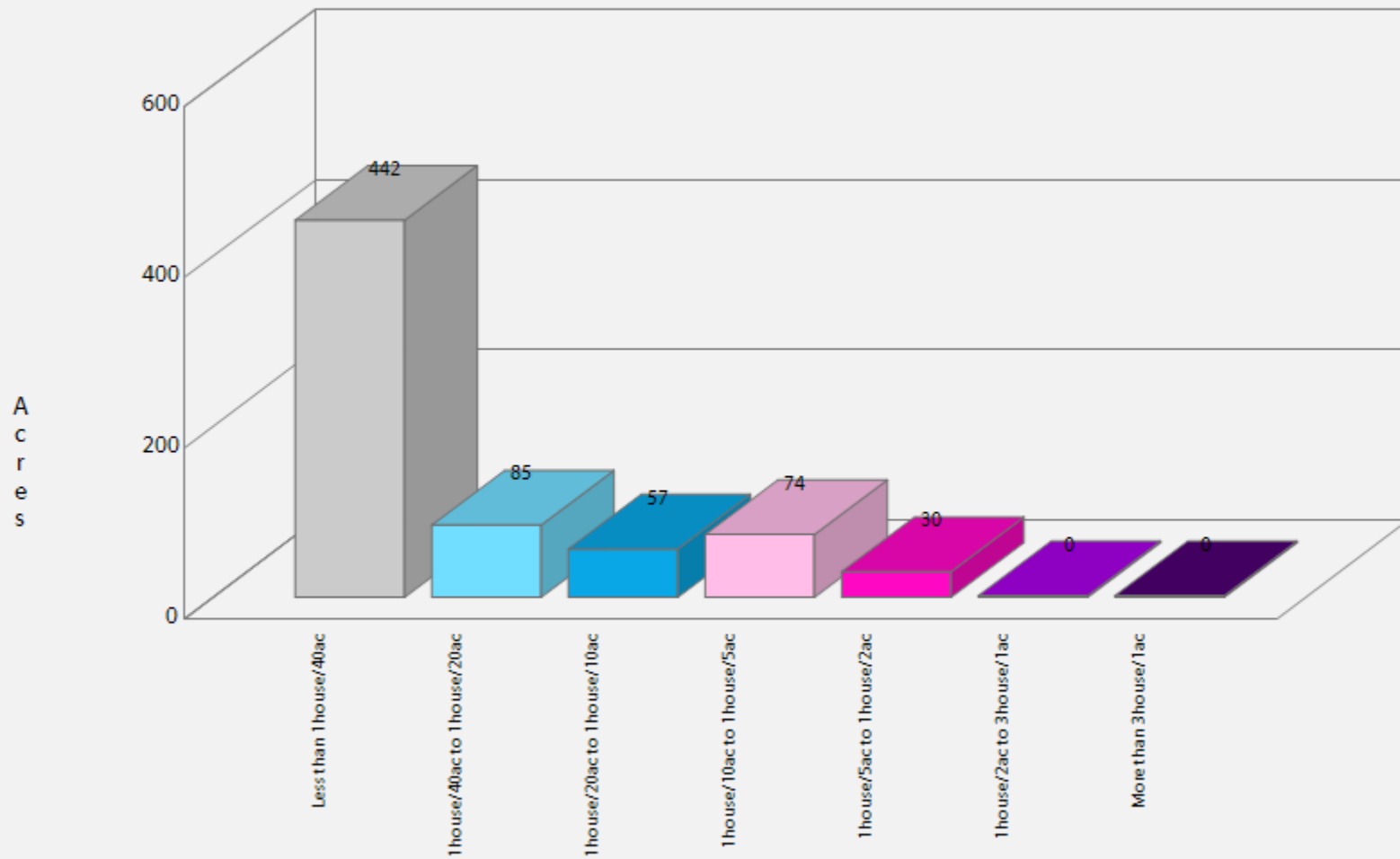

Wildland Urban Interface (WUI) Risk Index

Description

The Wildland-Urban Interface (WUI) Risk Index layer is a rating of the potential impact of a wildfire on people and their homes. The key input, WUI, reflects housing density (houses per acre) consistent with Federal Register National standards. The location of people living in the wildland-urban interface and rural areas is essential for defining potential wildfire impacts to people and homes.

The WUI Risk Index is derived using a response function modeling approach. Response functions are a method of assigning a net change in the value to a resource or asset based on susceptibility to fire at different intensity levels, such as flame length.

To calculate the WUI Risk Index, the WUI housing density data was combined with flame length data and response functions were defined to represent potential impacts. The response functions were defined by a team of experts led by Colorado State Forest Service mitigation planning staff. By combining flame length with the WUI housing density data, it is possible to determine where the greatest potential impact to homes and people is likely to occur.

The range of values is from -1 to -9, with -1 representing the least negative impact and -9 representing the most negative impact. For example, areas with high housing density and high flame lengths are rated -9, while areas with low housing density and low flame lengths are rated -1.

The WUI Risk Index has been calculated consistently for all areas in Colorado, which allows for comparison and ordination of areas across the entire state.

Data is modeled at a 30-meter cell resolution, which is consistent with other Colorado WRA layers.

	WUI Risk Class	Acres	Percent
	-1 (Least Negative Impact)	664	49.2 %
	-2	21	1.5 %
	-3	424	31.5 %
	-4	18	1.3 %
	-5	79	5.9 %
	-6	57	4.3 %
	-7	1	0.1 %
	-8	54	4.0 %
	-9 (Most Negative Impact)	30	2.2 %
	Total	1,349	100.0 %

Chandler Heights
WUI Risk Index

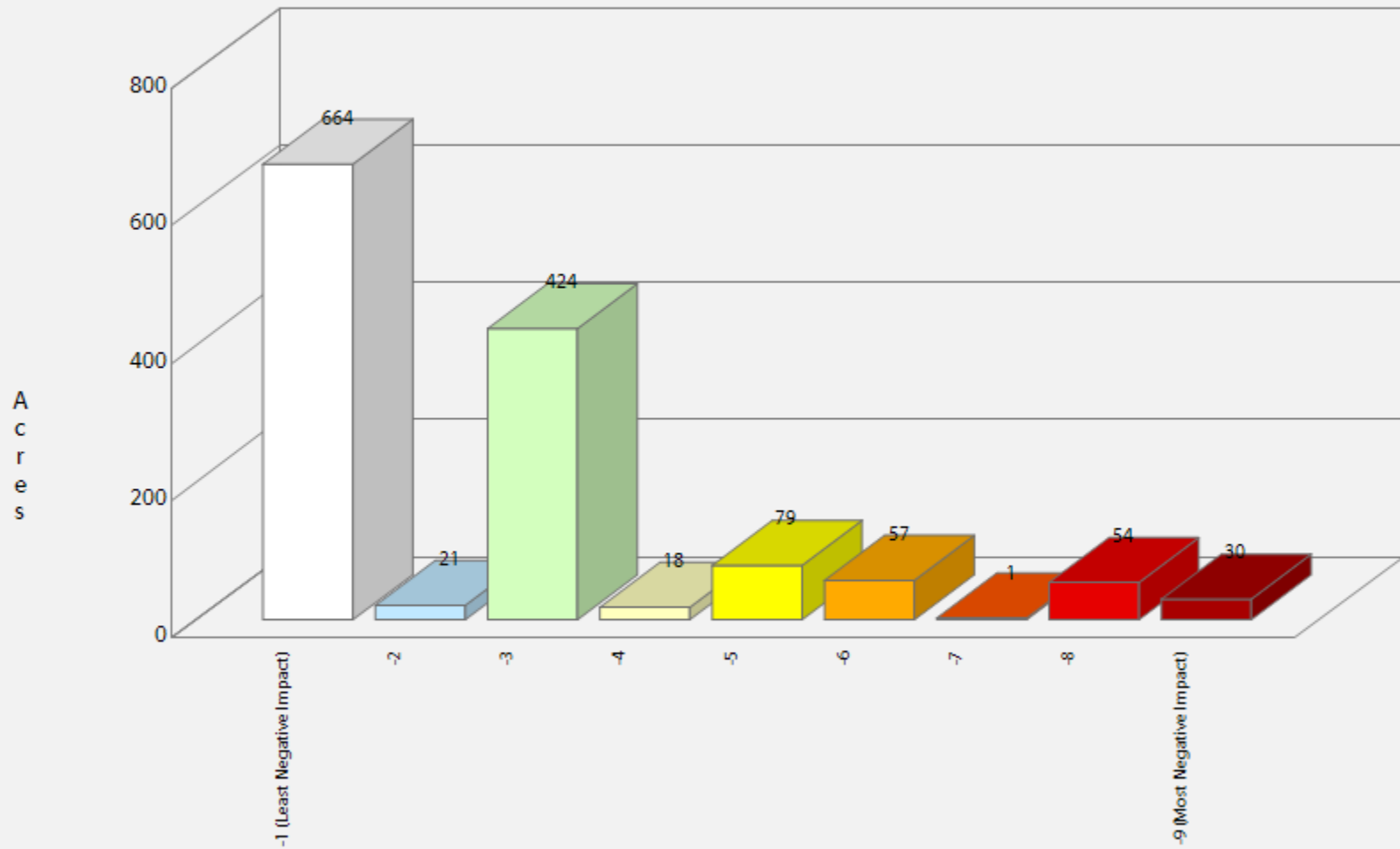

FireWise Communities

Description

Firewise Communities/USA® is a national recognition program that provides resources to inform communities how to adapt to living with wildfire and encourages neighbors to take action together to reduce their wildfire risk. Colorado communities that take the following five steps can be recognized as Firewise:

1. Form a Firewise board or committee
2. Obtain a wildfire risk assessment from the CSFS or local fire department, and create an action plan
3. Hold a Firewise event once per year
4. Invest a minimum of \$2 per capita in local Firewise actions for the year
5. Submit an application to Colorado’s Firewise liaison (Courtney Peterson, CSFS, at Courtney.Peterson@colostate.edu)

The FireWise Communities/USA dataset defines the boundaries of the recognized communities. The process for mapping Firewise Communities/USA (FWC) boundaries involved multiple steps:

1. Firewise Community leaders were contacted with a request for a FWC boundary in digital or hardcopy format, as delineated by a homeowner, Community Wildfire Protection Plan (CWPP), consultant, municipality, fire district or other local entity.
2. If a boundary was not available, the FWC leaders were provided a brief tutorial on how to draw a boundary using online mapping software. These boundaries were then shared in a file format recognized by Geographic

Information System (GIS) software and incorporated into a database.

3. If step 2 was not possible, FWC leaders were encouraged to draw a boundary polygon on maps, photos, plat or subdivision maps, or by verbal description of bounding properties, roads and other identifiable boundaries.
4. Boundaries provided by step 3 were digitized in GIS software and the results were then sent to the FWC leaders for confirmation.
5. If the provided FWC boundaries essentially followed CWPP boundaries, but with minor drawing errors, the FWC boundaries were “snapped” to match the CWPP boundaries. All other FWC boundaries were kept as delivered.

Note: These are estimated boundaries using a variety of methods with varying degrees of accuracy. These are not legal boundaries and should not be construed as such. The boundaries may overlap with CWPP areas and are subject to change over time as the communities develop, change, and continue to implement wildfire mitigation efforts.



To learn more about the Firewise Communities/USA recognition program or to fill out an application, visit www.firewise.org or www.csfs.colostate.edu/wildfire-mitigation/colorado-firewise-communities/.

***The designated project area does not contain
FireWise Community data***

Community Wildfire Protection Plans (CWPPs)

Description

A Community Wildfire Protection Plan (CWPP) is a document developed and agreed upon by a community to identify how the community will reduce its wildfire risk. CWPPs identify areas where fuels reduction is needed to reduce wildfire threats to communities and critical infrastructure, address protection of homes and other structures, and plan for wildfire response capability. The Colorado State Forest Service (CSFS) supports the development and implementation of CWPPs and provides resources, educational materials and information to those interested in developing CWPPs.

The CWPP dataset represents the boundaries of those areas that have developed a CWPP. Note that CWPPs can be developed by different groups at varying scales, such as county, Fire Protection District (FPD), community/subdivision, HOA, etc., and as such, can overlap. In addition, the CWPPs can be from different dates. Often a county CWPP is completed first with subsequently more detailed CWPPs done for local communities within that county or FPD. CO-WRAP provides a tool that allows the user to select the CWPP area and retrieve the CWPP document for review (PDF).

At a minimum, a CWPP should include:

- The wildland-urban interface (WUI) boundary, defined on a map, where people, structures and other community values are most likely to be negatively impacted by wildfire
- The CSFS, local fire authority and local government involvement and any additional stakeholders
- A narrative that identifies the community's values and fuel hazards



Community input is the foundation of a Community Wildfire Protection Plan that identifies community needs and garners community support.

- The community's plan for when a wildfire occurs
- An implementation plan that identifies areas of high priority for fuels treatments

CWPPs are not shelf documents and should be reviewed, tracked and updated. A plan stays alive when it is periodically updated to address the accomplishments of the community. Community review of progress in meeting plan objectives and determining areas of new concern where actions must be taken to reduce wildfire risk helps the community stay current with changing environment and wildfire mitigation priorities.

If your community is in an area at risk from wildfire, now is a good time to start working with neighbors on a CWPP and preparing for

future wildfires. Contact your local CSFS district to learn how to start this process and create a CWPP for your community:
<http://csfs.colostate.edu/pages/your-local-forester.html>.

For the **Chandler Heights** project area, there are **1** CWPPs areas that are totally or partially in the defined project area.

Community CWPP Name	CWPP Type	CSFS District	Acres Inside Project Area	Total Acres
Fremont County	County	Canon City	2,212	1,604,105
Total Acres			2,212	1,604,105

Chandler Heights
CWPP

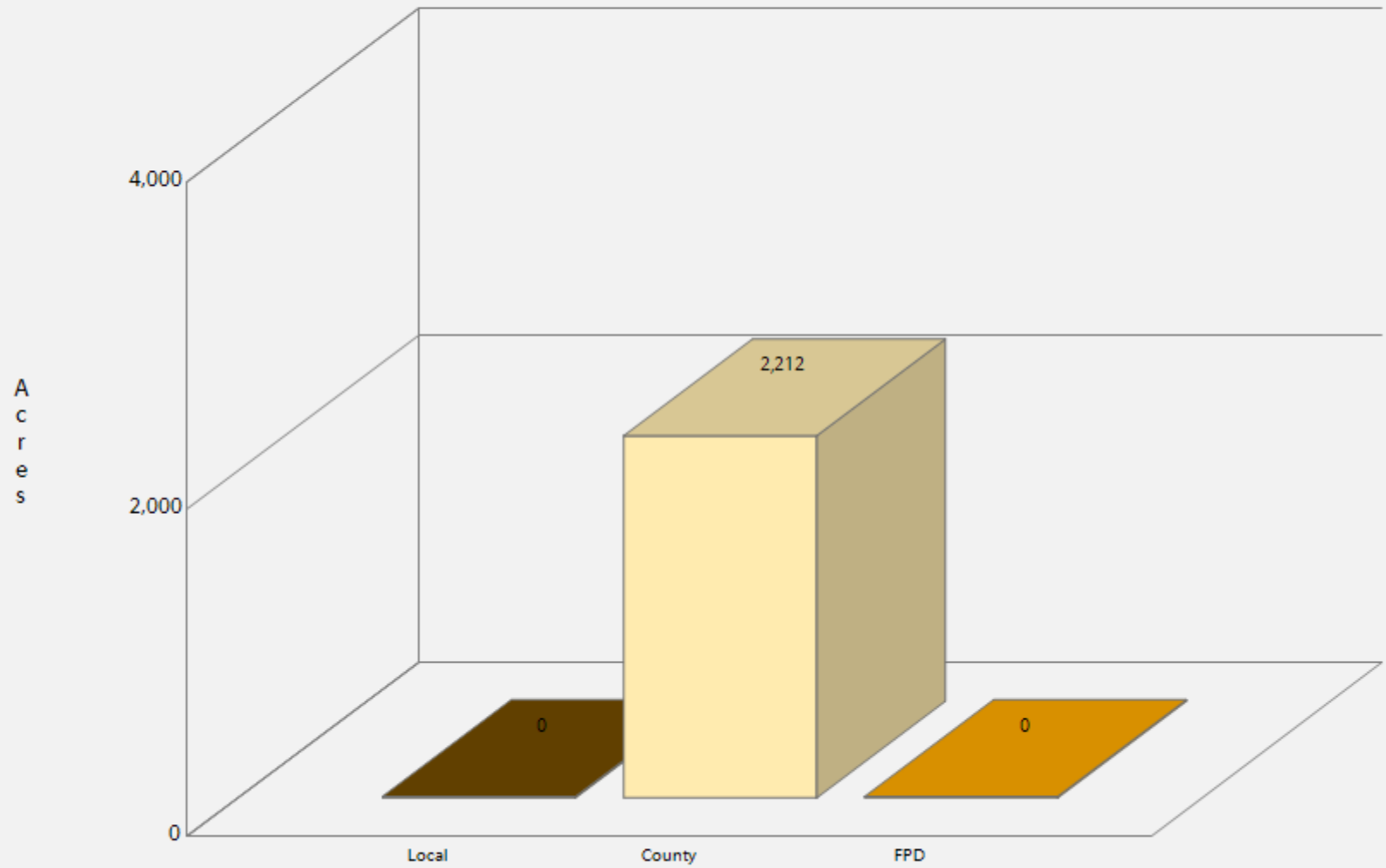

Forest Management Activities

Description

Forest management activities are practices implemented on the ground to address or reach management objectives. Forest management activities are also known as treatments. They are described in Forest Management Plans, Stewardship Plans, or Community Wildfire Protection Plans and are prescribed through processes that consider current condition, future desired condition, and best science-based management practices for the type of vegetation and local environmental conditions.

The data displayed in this layer was collected by CSFS for activities that occurred during the five-year period 2008 through 2012. The forest management activities are classified by general category and year of completion. More than one activity may have occurred within any polygon. Activities in any polygon may occur in more than one year.

The legend for the activities is presented on a per year basis and identifies the type of activity that has occurred for the project report area. Note that in some cases more than one activity may occur during a year and this is identified with a separate class.

A tool is provided within CO-WRAP to select treatment activity polygons on the map and review the information about the specific activity that has occurred for the selected year. Note that individual years from 2008 to 2012 are shown as separate layers within CO-WRAP and can be queried separately.



For the **Chandler Heights** project area, there were **no** forest management activities conducted between 2008 and 2012.

Wildfire Risk

Description

Wildfire Risk represents the possibility of loss or harm occurring from a wildfire. It is the primary output of the Colorado Wildfire Risk Assessment (Colorado WRA). Risk is derived by combining the Wildfire Threat and the Fire Effects assessment outputs. It identifies areas with the greatest potential impacts from a wildfire – i.e. those areas most at risk - considering all values and assets combined together.

Wildfire Risk combines the likelihood of a fire occurring (threat), with those areas of most concern that are adversely impacted by fire (fire effects), to derive a single overall measure of wildfire risk.

Since all areas in Colorado have risk calculated consistently, it allows for comparison and ordination of areas across the entire state.

Fire Effects are a key component of Wildfire Risk. Fire Effects are comprised of several inputs focusing on values and assets at risk. The purpose of Fire Effects is to identify those areas that have important values or assets that would be adversely impacted by a wildfire. Fire Effects inputs include Wildland Urban Interface, Forest Assets, Riparian Assets and Drinking Water Importance Areas (watersheds). Refer to the Values

Impacted Rating for more information about Fire Effects.

To aid in the use of Wildfire Risk for planning activities, the output values are categorized into five (5) classes. These are given general descriptions from Lowest to Highest Risk.



Wildfire Risk Class	Acres	Percent
Non-Burnable	9	0.7 %
Lowest Risk	477	35.3 %
Low Risk	836	62.0 %
Moderate Risk	27	2.0 %
High Risk	0	0.0 %
Highest Risk	0	0.0 %
Total	1,349	100.0 %

Chandler Heights
Wildfire Risk

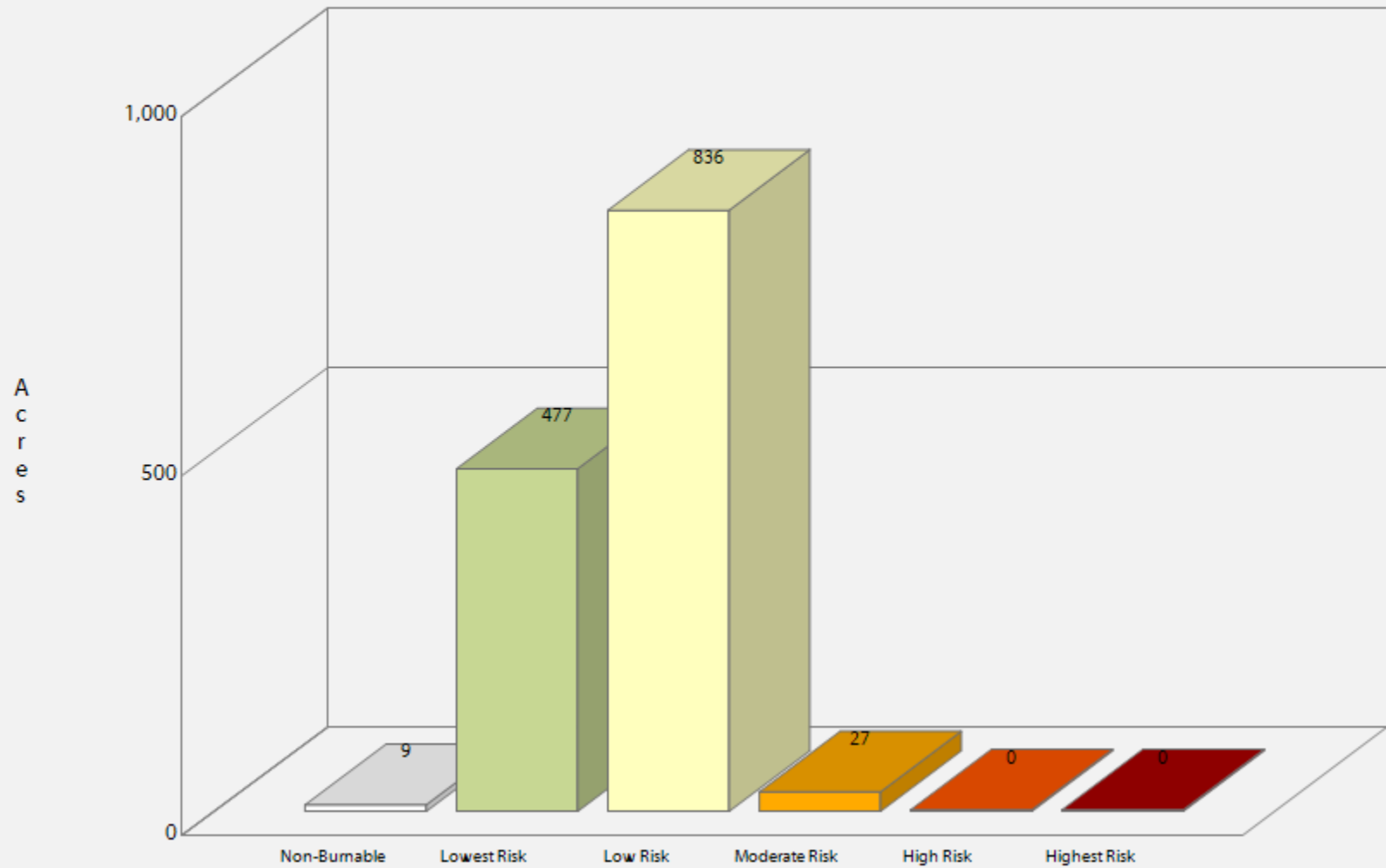

Wildfire Threat

Description

Wildfire Threat is the likelihood of an acre burning. Threat is derived by combining a number of landscape characteristics including surface fuels and canopy fuels, resultant fire behavior, historical fire occurrence, percentile weather derived from historical weather observations, and terrain conditions. These inputs are combined using analysis techniques based on established fire science.

The measure of wildfire threat used in the Colorado WRA is called Fire Threat Index (FTI). FTI combines the probability of an acre igniting (Fire Occurrence) and the expected final fire size based on rate of spread in four weather percentile categories. Since all areas in Colorado have FTI calculated consistently, it allows for comparison and ordination of areas across the entire state. For example, a high threat area in East Colorado is equivalent to a high threat area in West Colorado.

To aid in the use of Wildfire Threat for planning activities, the output values are categorized into five (5) classes. These are given general descriptions from Lowest to Highest Threat.

The threat map is derived at a 30-meter resolution. This scale of data was chosen to be consistent with the accuracy of the primary surface fuels dataset used in the assessment. While not appropriate for site specific analysis, it is appropriate for regional, county or local protection mitigation or prevention planning.

A more detailed description of the risk assessment algorithms is provided in the Colorado WRA Final Report, which can be downloaded from www.ColoradoWildfireRisk.com.

	Wildfire Threat Class	Acres	Percent
	Non-Burnable	54	4.0 %
	Lowest Threat	1,005	74.5 %
	Low Threat	172	12.7 %
	Moderate Threat	118	8.8 %
	High Threat	0	0.0 %
	Highest Threat	0	0.0 %
	Total	1,349	100.0 %

Chandler Heights
Wildfire Threat

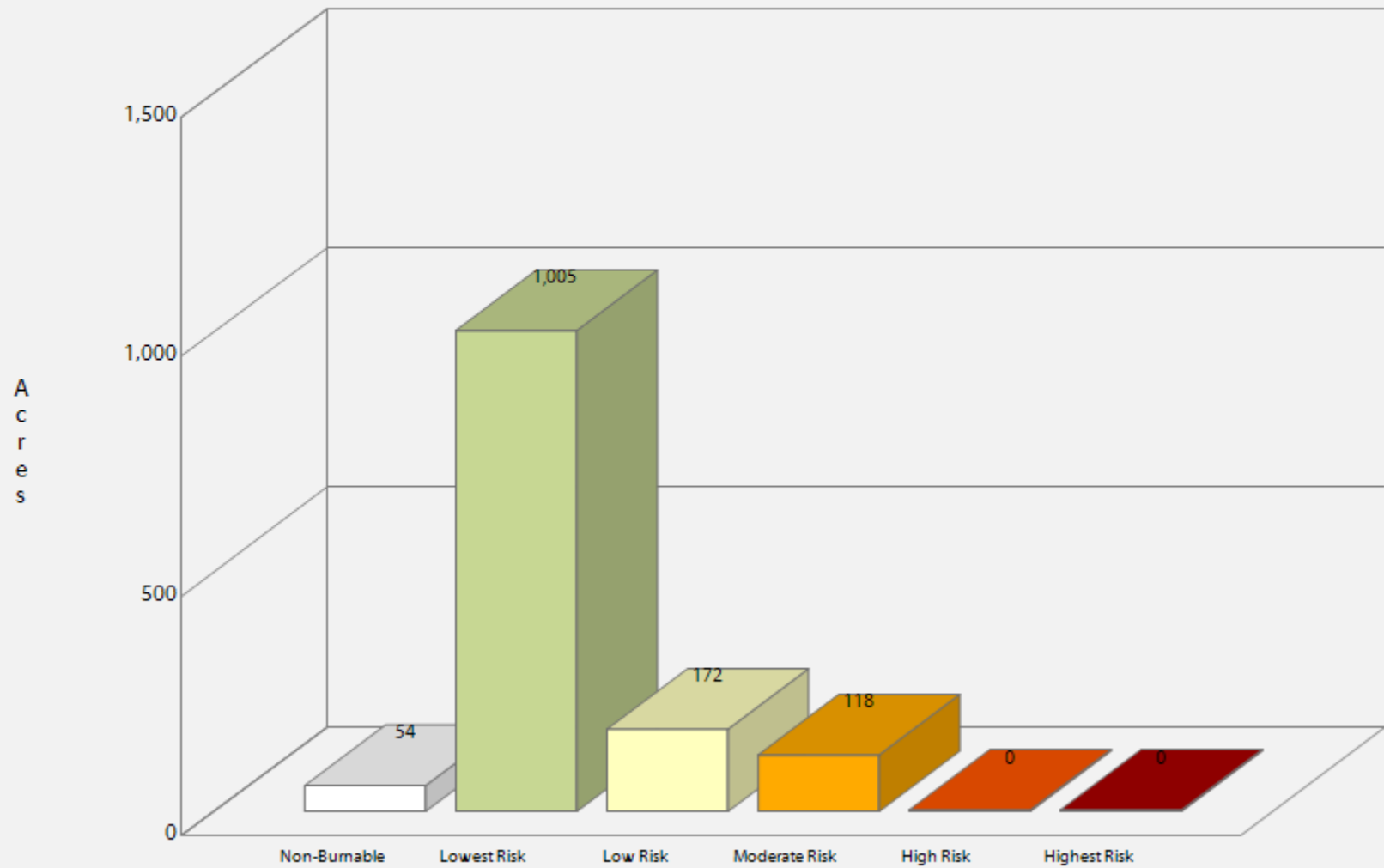

Values Impacted Rating

Description

Represents those values or assets that would be adversely impacted by a wildfire. The Values Impacted Rating (VIR) is an overall Fire Effects rating that combines the risk ratings for Wildland Urban Interface (WUI), Forest Assets, Riparian Assets, and Drinking Water Importance Areas into a single measure of values-at-risk. The individual ratings for each value layer were derived using a Response Function approach.

Response functions are a method of assigning a net change in the value to a resource or asset based on susceptibility to fire at different intensity levels. A resource or asset is any of the Fire Effects input layers, such as WUI, Forest Assets, etc. These net changes can be adverse (negative) or positive (beneficial).

Calculating the VIR at a given location requires spatially defined estimates of the intensity of fire integrated with the identified resource value. This interaction is quantified through the use of response functions that estimate expected impacts to resources or assets at the specified fire intensity levels. The measure of fire intensity level used in the Colorado assessment is flame length for a location. Response Function outputs were derived for each input data set and then combined to derive the Values Impacted Rating.

Different weightings are used for each of the input layers with the highest priority placed on protection of people and structures (i.e. WUI). The weightings represent the value associated with those assets. Weightings were developed by a team of experts during the assessment to reflect priorities for fire protection planning in Colorado. Refer to the Colorado WRA Final Report for more information about the layer weightings.

Since all areas in Colorado have the VIR calculated consistently, it allows for comparison and ordination of areas across the entire state. The VIR data was derived at a 30-meter resolution.

	VIR Class	Acres	Percent
	-1 (Least Negative Impact)	1	0.0 %
	-2	571	42.6 %
	-3	566	42.2 %
	-4	115	8.6 %
	-5	84	6.3 %
	-6	4	0.3 %
	-7	0	0.0 %
	-8	0	0.0 %
	-9 (Most Negative Impact)	0	0.0 %
	Total	1,340	100.0 %

Chandler Heights
Values Impacted Rating

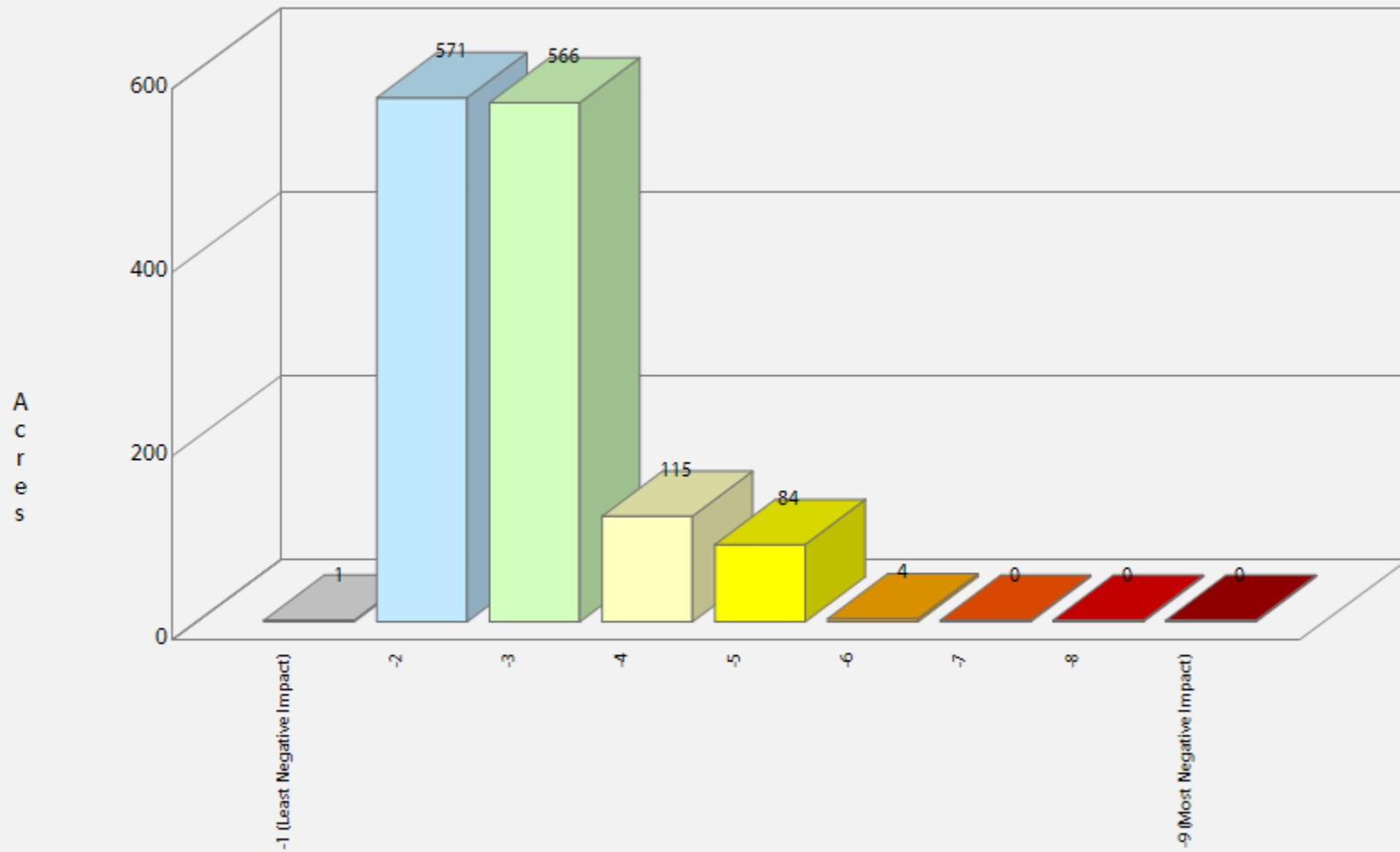

Suppression Difficulty Rating

Description

Reflects the difficulty or relative cost to suppress a fire given the terrain and vegetation conditions that may impact machine operability. This layer is an overall index that combines the slope steepness and the fuel type characterization to identify areas where it would be difficult or costly to suppress a fire due to the underlying terrain and vegetation conditions that would impact machine operability (in particular Type II dozer).

The rating was calculated based on the fireline production rates for hand crews and engines with modifications for slope, as documented in the NWCG Fireline Handbook 3, PMS 401-1.

The burnable fuel models in the Colorado WRA were grouped into three categories: slow (0-66 feet), medium (67-165 feet) and fast (greater than 165 feet).

Fireline production capability on five slope classes was used as the basic reference to obtain the suppression difficulty score. To remain constant with the Value Impacted Rating output values, a response function (-1 to -9) is assigned to each combination of fuel model group (slow, medium and fast) and slope category.

SDR Class	Acres	Percent
-1 (Least Difficult)	0	0.0 %
-2	1,189	91.7 %
-3	0	0.0 %
-4	102	7.8 %
-5	4	0.3 %
-6	0	0.0 %
-7	2	0.1 %
-8	0	0.0 %
-9 (Most Difficult)	0	0.0 %
Total	1,296	100.0 %

Chandler Heights Suppression Difficulty Rating

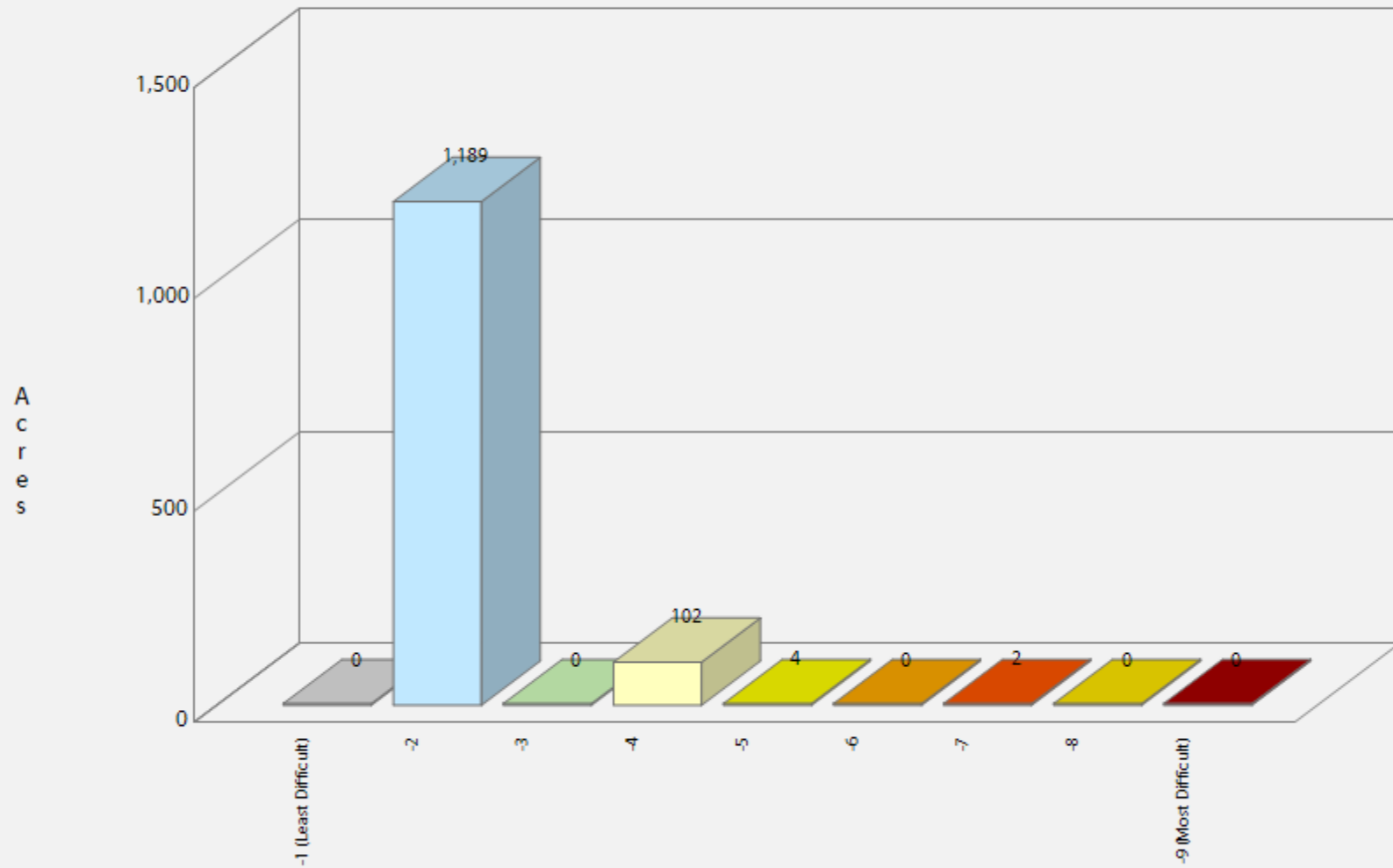

Fire Occurrence

Description

Fire Occurrence is an ignition density that represents the likelihood of a wildfire starting based on historical ignition patterns. Occurrence is derived by modeling historic wildfire ignition locations to create an average ignition rate map. The ignition rate is measured in the number of fires per year per 1000 acres.

Historic fire report data was used to create the ignition points for all Colorado fires. Data was obtained from the West Wide Risk Assessment project. The compiled fire occurrence database was cleaned to remove duplicate records and to correct inaccurate locations. The database was then modeled to create a density map reflecting historical fire ignition rates.

The measure of fire occurrence used in the Colorado WRA is called Fire Occurrence. Since all areas in Colorado have ignition density calculated consistently, it allows for comparison and ordination of areas across the entire state. For example, a high occurrence area in East Colorado is equivalent to a high occurrence area in West Colorado.

Fire Occurrence is a key input into the calculation of the Wildfire Threat output. In particular, with most Colorado fires being human caused, there is a repeatable spatial pattern of fire ignitions over time. This pattern identifies areas where wildfires are most likely to ignite and prevention efforts can be planned accordingly.

To aid in the use of wildfire ignition density for planning activities, the output values are categorized into seven (7) classes reflecting

average annual ignition rates. These are given general descriptions from Low to Very High. Seven classes are used to present finer detail for mapping purposes so that transitional areas can be easily identified.

The class breaks are determined by analyzing the Fire Occurrence output values for the entire state and determining cumulative percent of acres (i.e. Class 7 has the top 3.5% of acres with the highest occurrence rate). Refer to the Colorado WRA Final Report for a more detailed description of the mapping classes and the methods used to derive these.

The Fire Occurrence map is derived at a 30-meter resolution. This scale of data was chosen to be consistent with the accuracy of the primary surface fuels dataset used in the assessment. While not sufficient for site specific analysis, it is appropriate for regional, county or local protection mitigation or prevention planning.

A more detailed description of the risk assessment algorithms is provided in the Colorado WRA Final Report, which can be downloaded from www.ColoradoWildfireRisk.com.

	Fire Occurrence Class	Acres	Percent
	Non-Burnable	57	4.2 %
	1 (Lowest Occurrence)	1,292	95.8 %
	2	0	0.0 %
	3	0	0.0 %
	4	0	0.0 %
	5	0	0.0 %
	6	0	0.0 %
	7 (Highest Occurrence)	0	0.0 %
	Total	1,349	100.0 %

Chandler Heights Fire Occurrence

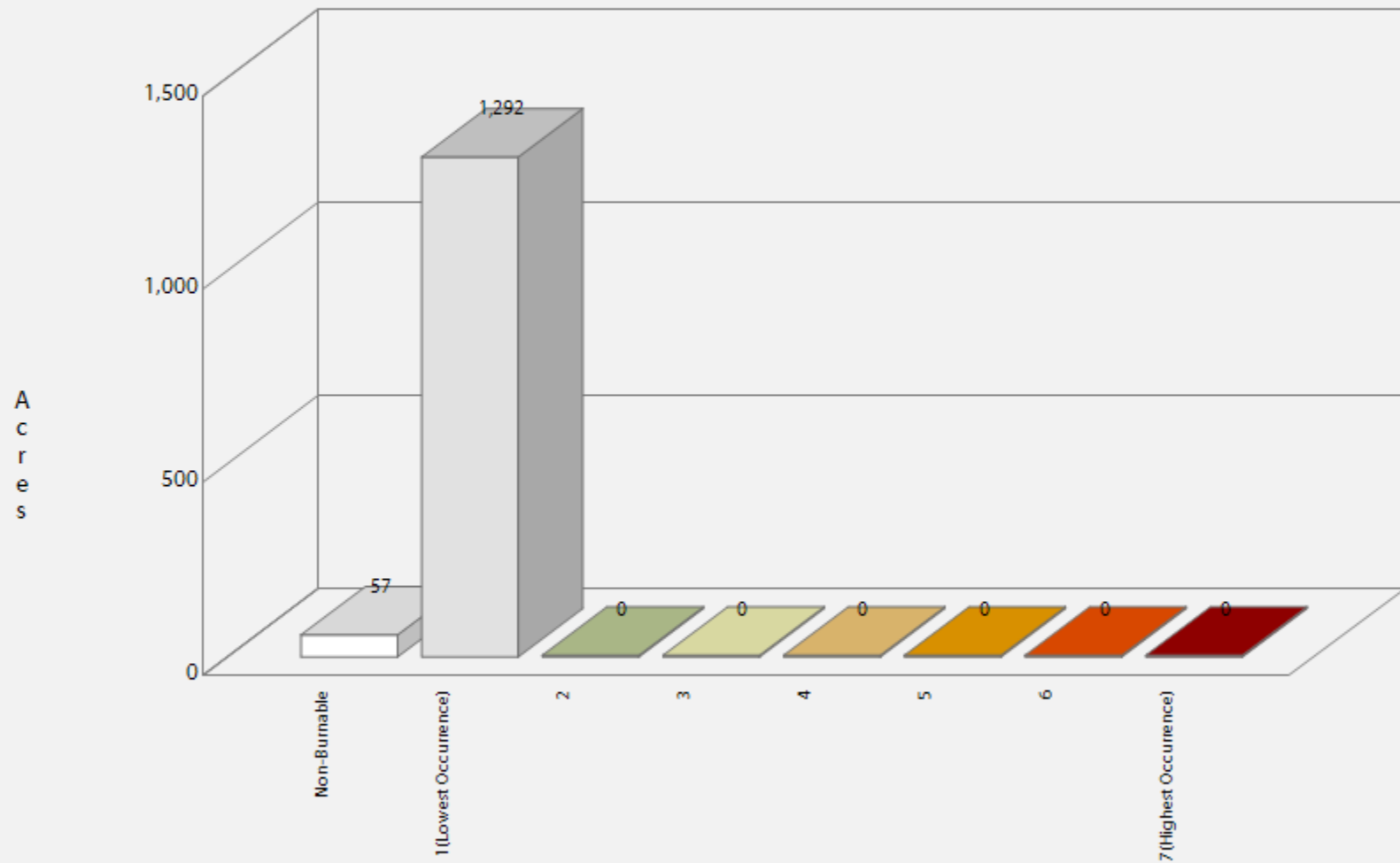

Fire History Statistics

Description

Fire history statistics provide insight as to the number of fires, acres burned and cause of fires in Colorado. These statistics are useful for prevention and mitigation planning. They can be used to quantify the level of fire business, determine the time of year most fires typically occur and develop a fire prevention campaign aimed at reducing a specific fire cause.

Ten years of historic fire report data was used to create the fire occurrence summary charts. Wildfire Ignition data was compiled from federal and local sources for the years 1999 through 2008. Federal wildfire ignitions were spatially referenced by latitude and longitude coordinates, and state and local wildfire ignitions were spatially referenced by zip code. All ignitions references were updated to remove duplicate records and correct inaccurate locations.

Federal wildfire ignitions are symbolized in CO-WRAP by the cause of fire. Fire reports were gathered from the following federal data sources:

- US Forest Service
- US Fish and Wildlife Service
- Bureau of Land Management
- Bureau of Indian Affairs
- National Park Service

State wildfire ignitions were gathered from fire department reports submitted by:

- Volunteer Fire Departments
- Combination Fire Departments (paid and volunteer)
- Paid Fire Departments
- Fire Protection Districts
- Counties

Chandler Heights
**Number of Wildfires Reported by Agency
 1999 - 2008**

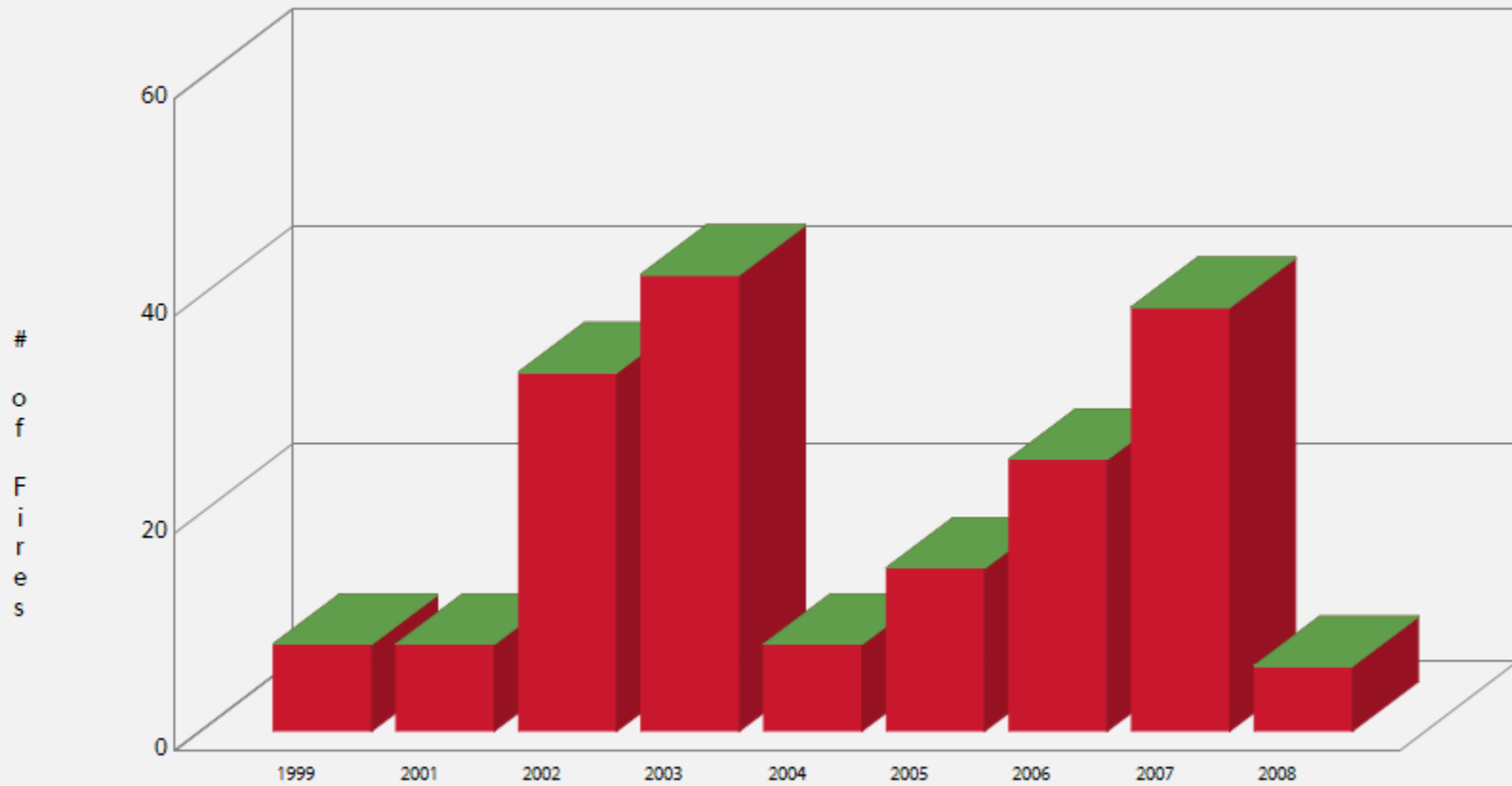

	1999	2001	2002	2003	2004	2005	2006	2007	2008
State	8	8	33	42	8	15	25	39	6
Federal	0	0	0	0	0	0	0	0	0

Chandler Heights
Wildfire Acres Reported by Agency
1999 - 2008

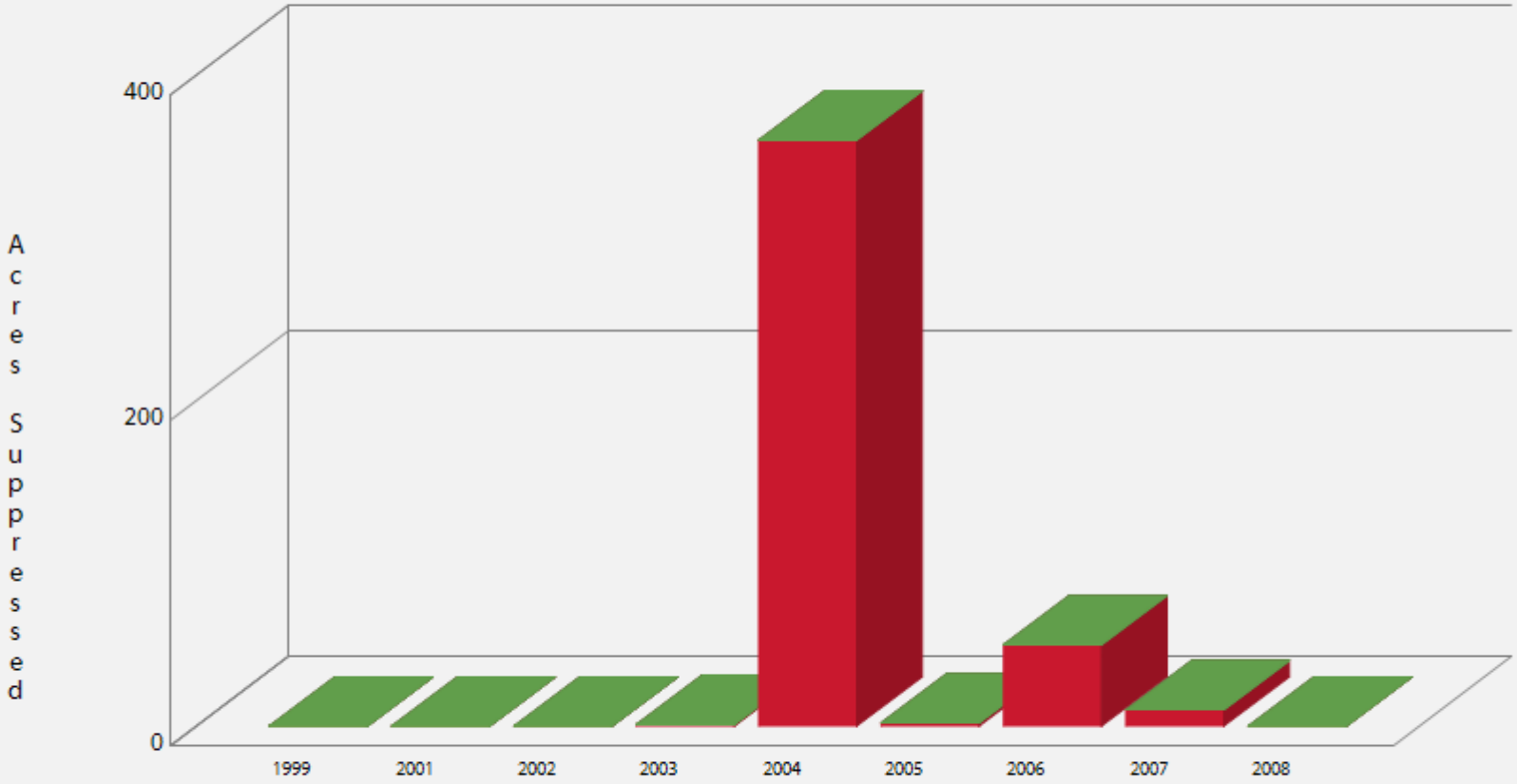

	1999	2001	2002	2003	2004	2005	2006	2007	2008
State	0	0	0	1	360	2	50	10	0
Federal	0	0	0	0	0	0	0	0	0

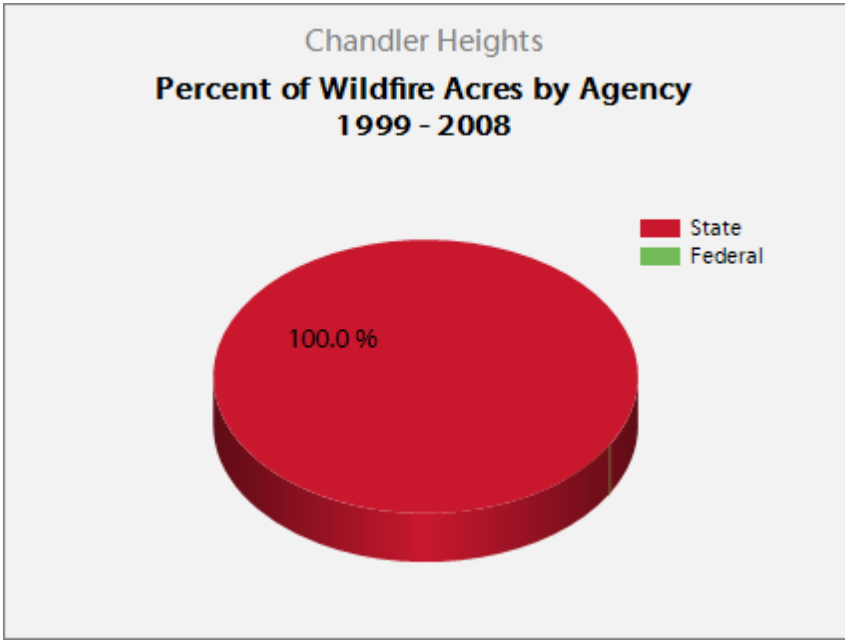
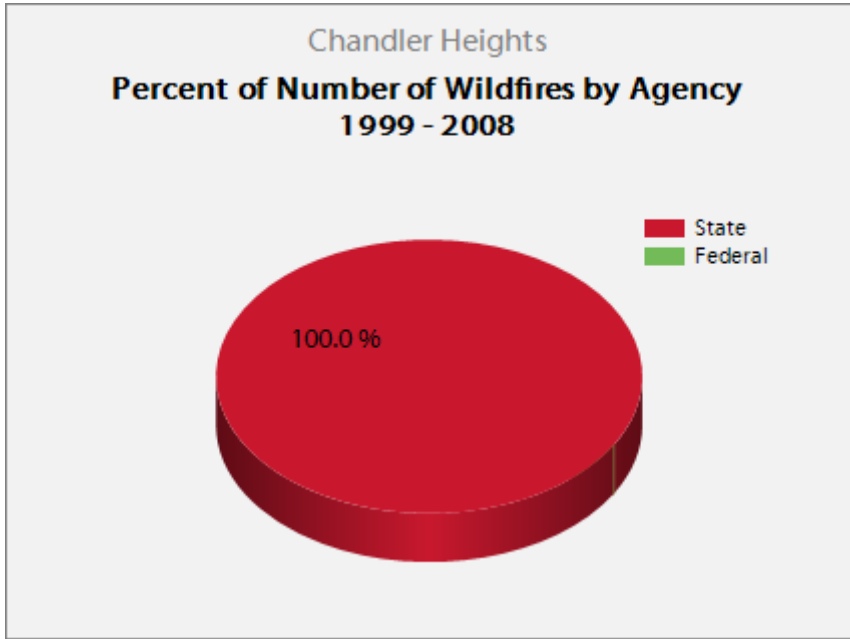

Chandler Heights
Cause of Wildfires Reported by Agency
1999 - 2008

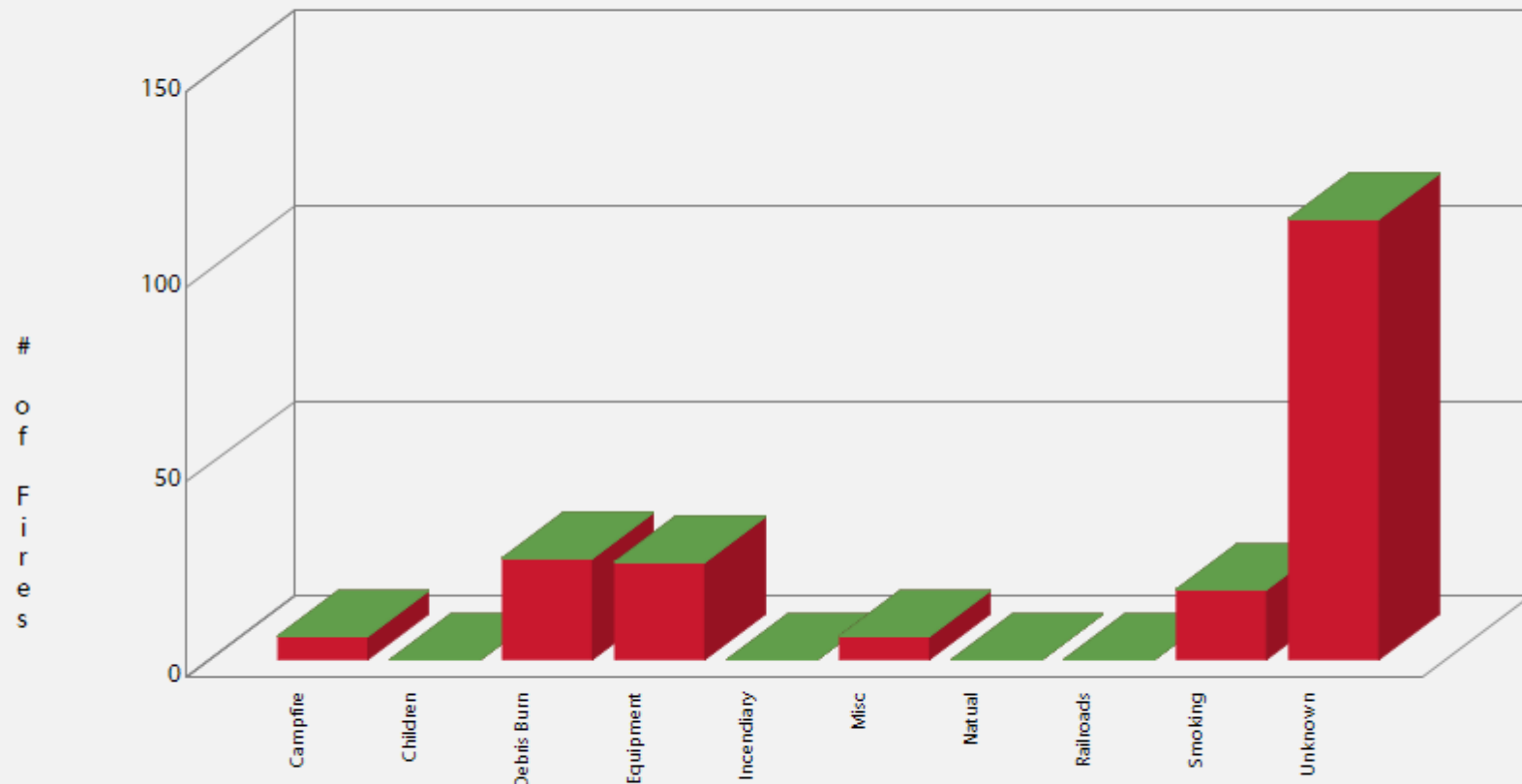

	Campfire	Children	Debris Burn	Equipment	Incendiary	Misc	Natual	Railroads	Smoking	Unknown
State	6	0	26	25	0	6	0	0	18	113
Federal	0	0	0	0	0	0	0	0	0	0

Chandler Heights

Number of Wildfires Reported per Month by Agency 1999 - 2008

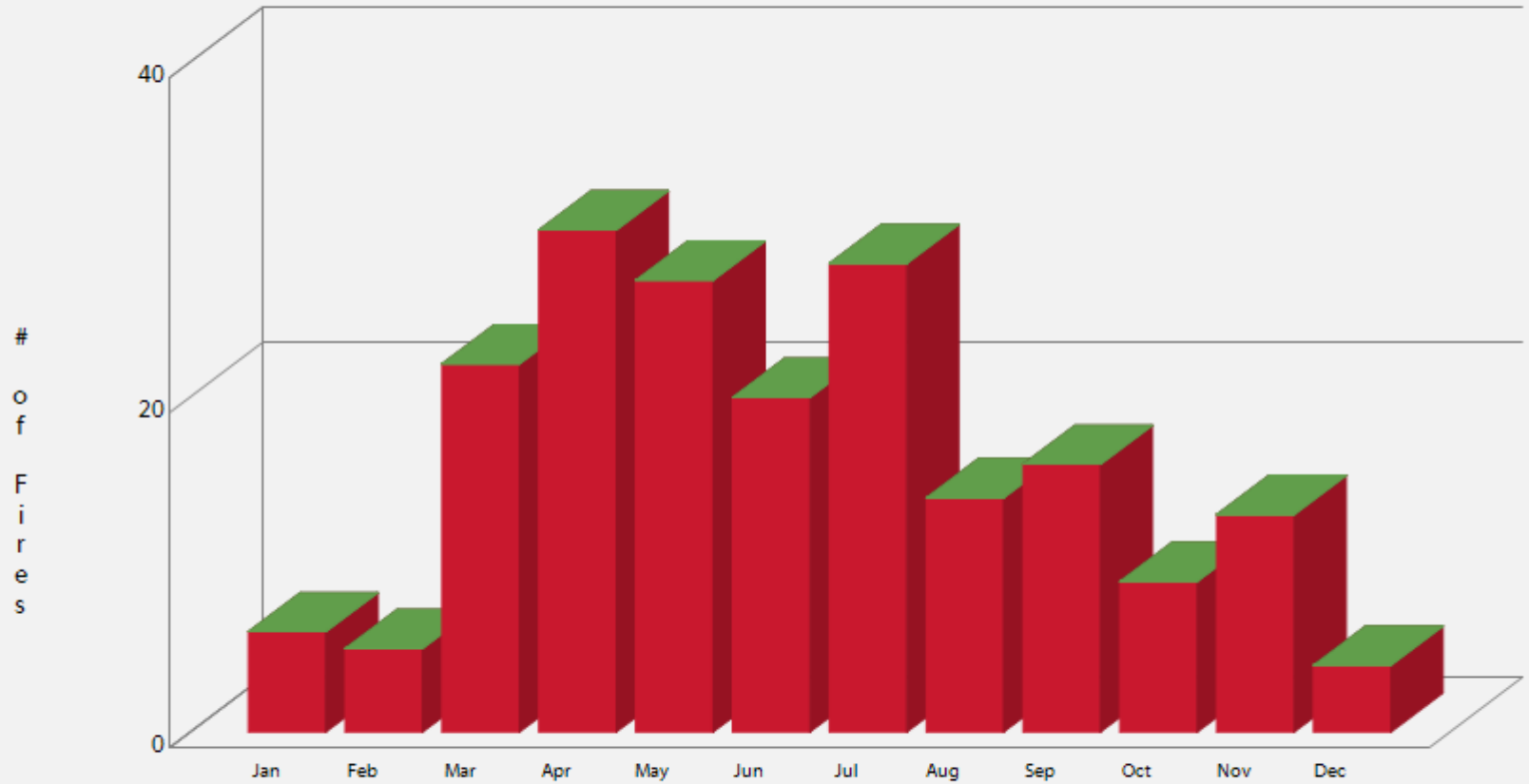

	Jan	Feb	Mar	Apr	May	Jun	Jul	Aug	Sep	Oct	Nov	Dec
State	6	5	22	30	27	20	28	14	16	9	13	4
Federal	0	0	0	0	0	0	0	0	0	0	0	0

Fire Behavior

Description

Fire behavior is the manner in which a fire reacts to the following environmental influences:

1. Fuels
2. Weather
3. Topography



Fire behavior characteristics are attributes of wildland fire that pertain to its spread, intensity, and growth. Fire behavior characteristics utilized in the Colorado WRA include fire type, rate of spread, flame length and fireline intensity (fire intensity scale). These metrics are used to determine the potential fire behavior under different weather scenarios. Areas that exhibit moderate to high fire behavior potential can be identified for mitigation treatments, especially if these areas are in close proximity to homes, business, or other assets.



Fuels

The Colorado WRA includes composition and characteristics for both surface fuels and canopy fuels. Assessing canopy fire potential and surface fire potential allows identification of areas where significant increases in fire behavior affects the potential of a fire to transition from a surface fire to a canopy fire.

Fuel datasets required to compute both surface and canopy fire potential include:

- **Surface Fuels** are typically categorized into one of four primary fuel types based on the primary carrier of the surface fire: 1) grass, 2) shrub/brush, 3) timber litter, and 4) slash. They are generally referred to as fire behavior fuel models and provide the input parameters needed to compute surface fire behavior.
- **Canopy Cover** is the horizontal percentage of the ground surface that is covered by tree crowns. It is used to compute wind-reduction factors and shading.
- **Canopy Ceiling Height/Stand Height** is the height above the ground of the highest canopy layer where the density of the crown mass within the layer is high enough to support vertical movement of a fire. A good estimate of canopy ceiling height is the average height of the dominant and co-dominant trees in a stand. It is used to compute wind reduction to mid-flame height, and spotting distances from torching trees (Fire Program Solutions, L.L.C, 2005).

- **Canopy Base Height** is the lowest height above the ground above which sufficient canopy fuel exists to vertically propagate fire (Scott & Reinhardt, 2001). Canopy base height is a property of a plot, stand or group of trees, not an individual tree. For fire modeling, canopy base height is an effective value that incorporates ladder fuels, such as tall shrubs and small trees. Canopy base height is used to determine whether a surface fire will transition to a canopy fire.
- **Canopy Bulk Density** is the mass of available canopy fuel per unit canopy volume (Scott & Reinhardt, 2001). Canopy bulk density is a bulk property of a stand, plot or group of trees, not an individual tree. Canopy bulk density is used to predict whether an active crown fire is possible.

Weather

Environmental weather parameters needed to compute fire behavior characteristics include 1-hour, 10-hour and 100-hour time-lag fuel moistures, herbaceous fuel moisture, woody fuel moisture and the 20-foot, 10-minute average wind speed. To collect this information, weather influence zones were established across the state. A weather influence zone is an area where, for analysis, the weather on any given day is considered uniform.

Within each weather influence zone, historical daily weather is gathered to compile a weather dataset from which four percentile weather categories are created. The percentile weather categories are intended to represent low, moderate, high and extreme fire

weather days. Fire behavior outputs are computed for each percentile weather category to determine fire potential under different weather scenarios.

The four percentile weather categories include:

- Low Weather Percentile (0 – 15%)
- Moderate Weather Percentile (16 – 90%)
- High Weather Percentile (91 – 97%)
- Extreme Weather Percentile (98 – 100%)

For a detailed description of the methodology, refer to the WWA Final Report at www.ColoradoWildfireRisk.com.

Topography

Topography datasets required to compute fire behavior characteristics are elevation, slope and aspect.

FIRE BEHAVIOR CHARACTERISTICS

Fire behavior characteristics provided in this report include:

- **Characteristic Rate of Spread**
- **Characteristic Flame Length**
- **Fire Intensity Scale**
- **Fire Type – Extreme Weather**

Characteristic Rate of Spread

Characteristic Rate of Spread is the typical or representative rate of spread of a potential fire based on a weighted average of four percentile weather categories. Rate of spread is the speed with which a fire moves in a horizontal direction across the landscape, usually expressed in chains per hour (ch/hr) or feet per minute (ft/min). For purposes of the Colorado WRA, this measurement represents the maximum rate of spread of the fire front. Rate of Spread is used in the calculation of Wildfire Threat in the Colorado WRA.

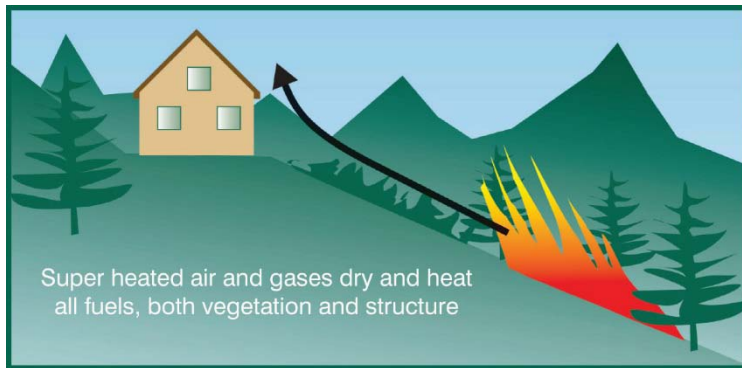

Rate of spread is a fire behavior output, which is influenced by three environmental factors - fuels, weather, and topography. Weather is by far the most dynamic variable as it changes frequently. To account for this variability, four percentile weather categories were created from historical weather observations to represent low, moderate, high, and extreme weather days for each weather influence zone in Colorado. A weather influence zone is an area where, for analysis purposes, the weather on any given day is considered uniform. There are 11 weather influence zones in Colorado.

This output represents the weighted average for all four weather percentiles. While not shown in this report, the individual percentile weather ROS outputs are available in the Colorado WRA data.

	Rate of Spread	Acres	Percent
	Non-Burnable	57	4.2 %
	Very Low (0 - 2 ch/hr)	0	0.0 %
	Low (2 - 4 ch/hr)	0	0.0 %
	Moderate (4 - 12 ch/hr)	0	0.0 %
	High (12 - 40 ch/hr)	129	9.5 %
	Very High (40 - 60 ch/hr)	199	14.7 %
	Extreme (60+ ch/hr)	965	71.5 %
	Total	1,349	100.0 %

Chandler Heights
Characteristic Rate of Spread

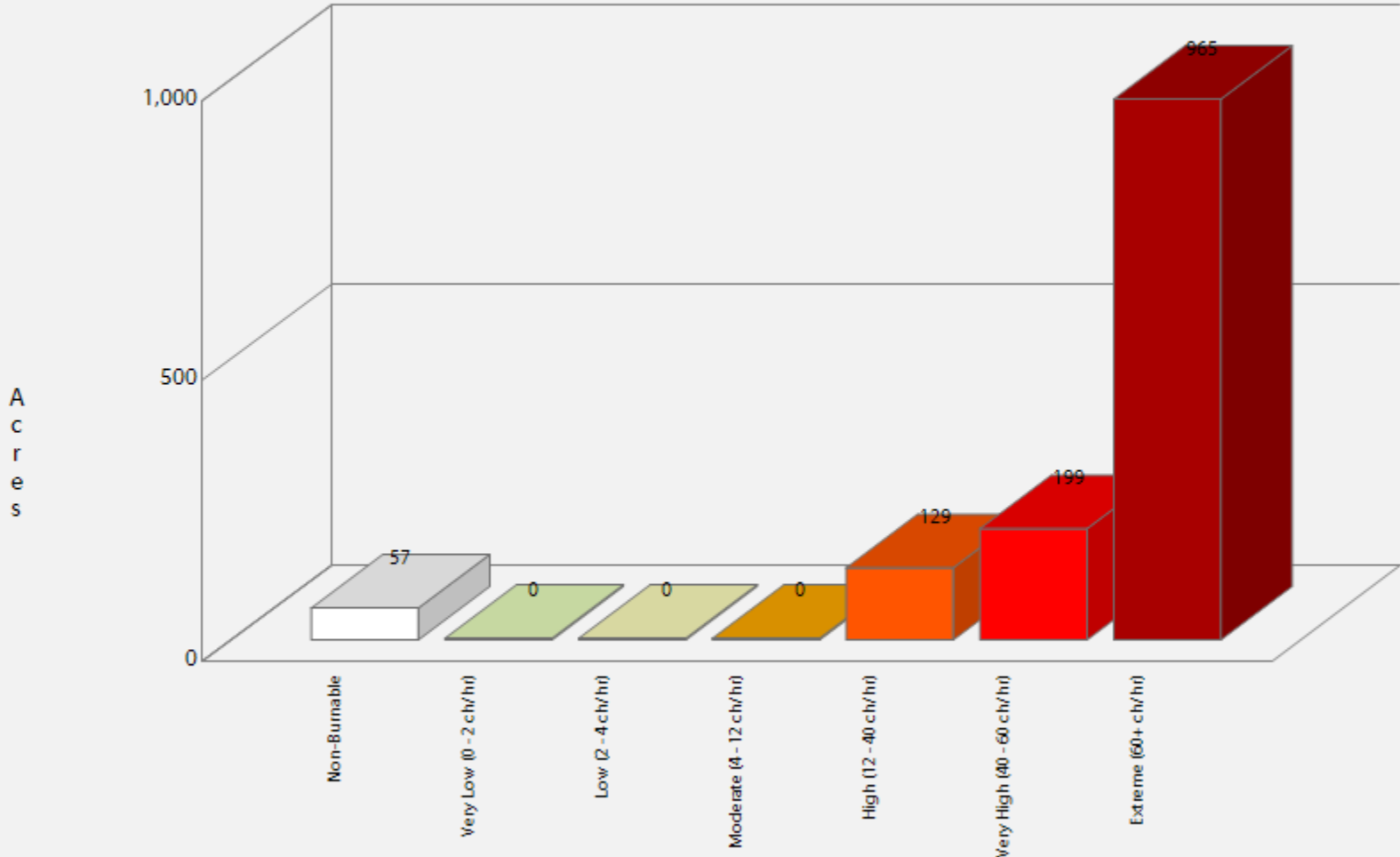

Characteristic Flame Length

Characteristic Flame Length is the typical or representative flame length of a potential fire based on a weighted average of four percentile weather categories. Flame Length is defined as the distance between the flame tip and the midpoint of the flame depth at the base of the flame, which is generally the ground surface. It is an indicator of fire intensity and is often used to estimate how much heat the fire is generating. Flame length is typically measured in feet (ft). Flame length is the measure of fire intensity used to generate the Fire Effects outputs for the Colorado WRA.

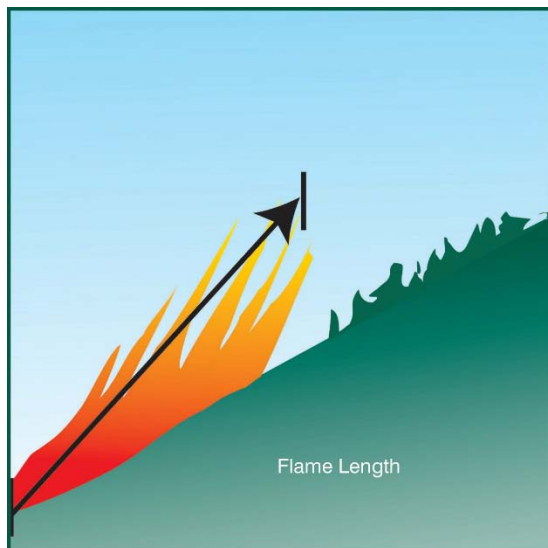

Flame length is a fire behavior output, which is influenced by three environmental factors - fuels, weather, and topography. Weather is by far the most dynamic variable as it changes frequently. To account for this variability, four percentile weather categories were created from historical weather observations to represent low, moderate, high, and extreme weather days for each weather influence zone in Colorado. A weather influence zone is an area where, for analysis purposes, the weather on any given day is considered uniform. There are 11 weather influence zones in Colorado.

This output represents the weighted average for all four weather percentiles. While not shown in this report, the individual percentile weather Flame Length outputs are available in the Colorado WRA data.

	Flame Length	Acres	Percent
	Non-Burnable	11	0.8 %
	Very Low (0 - 1 ft)	0	0.0 %
	Low (1 - 4 ft)	1	0.1 %
	Moderate (4 - 8 ft)	1,202	89.1 %
	High (8 - 12 ft)	81	6.0 %
	Very High (12 - 25 ft)	54	4.0 %
	Extreme (25+ ft)	0	0.0 %
Total		1,349	100.0 %

Chandler Heights Characteristic Flame Length

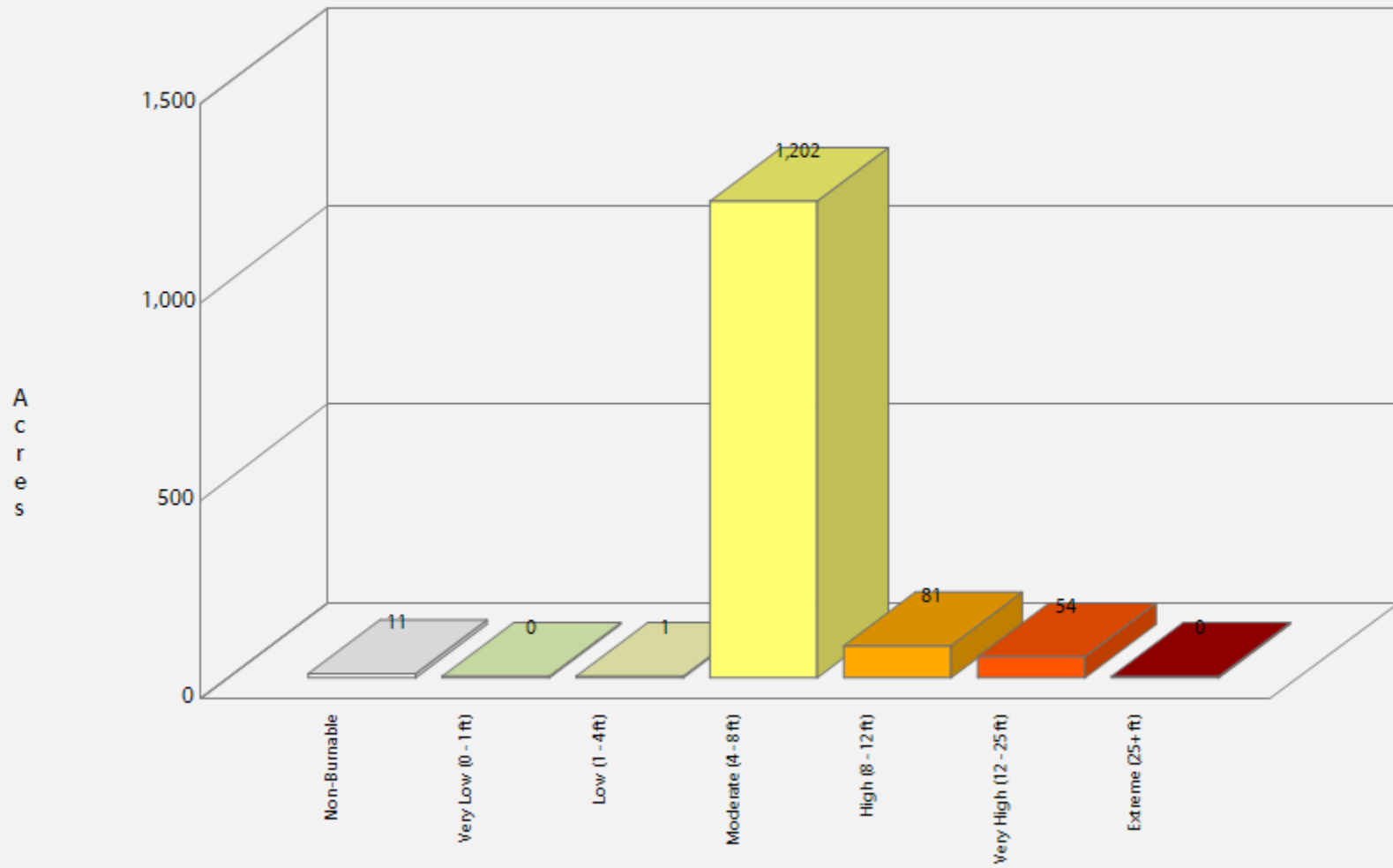

Fire Intensity Scale

Description

Fire Intensity Scale (FIS) specifically identifies areas where significant fuel hazards and associated dangerous fire behavior potential exist. Similar to the Richter scale for earthquakes, FIS provides a standard scale to measure potential wildfire intensity. FIS consist of five (5) classes where the order of magnitude between classes is ten-fold. The minimum class, Class 1, represents very low wildfire intensities and the maximum class, Class 5, represents very high wildfire intensities.

1. **Class 1, Lowest Intensity:**

Very small, discontinuous flames, usually less than 1 foot in length; very low rate of spread; no spotting. Fires are typically easy to suppress by firefighters with basic training and non-specialized equipment.

2. **Class2, Low:**

Small flames, usually less than two feet long; small amount of very short range spotting possible. Fires are easy to suppress by trained firefighters with protective equipment and specialized tools.

3. **Class 3, Moderate:**

Flames up to 8 feet in length; short-range spotting is possible. Trained firefighters will find these fires difficult to suppress without support from aircraft or engines, but dozer and plows are generally effective. Increasing potential for harm or damage to life and property.

4. **Class 4, High:**

Large Flames, up to 30 feet in length; short-range spotting common; medium range spotting possible. Direct attack by trained firefighters, engines, and dozers is generally ineffective, indirect attack may be effective. Significant potential for harm or damage to life and property.

5. **Class 5, Highest Intensity:**

Very large flames up to 150 feet in length; profuse short-range spotting, frequent long-range spotting; strong fire-induced winds. Indirect attack marginally effective at the head of the fire. Great potential for harm or damage to life and property.

Wildfire Threat and Fire Intensity Scale are designed to complement each other. Unlike Wildfire Threat, the Fire Intensity Scale does not incorporate historical occurrence information. It only evaluates the potential fire behavior for an area, regardless if any fires have occurred there in the past. This additional information allows mitigation planners to quickly identify areas where dangerous fire behavior potential exists in relationship to nearby homes or other valued assets.

Since all areas in Colorado have fire intensity scale calculated consistently, it allows for comparison and ordination of areas across the entire state. For example, a high fire intensity area in Eastern Colorado is equivalent to a high fire intensity area in Western Colorado.

Fire intensity scale is a fire behavior output, which is influenced by three environmental factors - fuels, weather, and topography. Weather is by far the most dynamic variable as it changes frequently.

To account for this variability, four percentile weather categories were created from historical weather observations to represent low, moderate, high, and extreme weather days for each weather influence zone in Colorado. A weather influence zone is an area where, for analysis purposes, the weather on any given day is considered uniform. There are 11 weather influence zones in

Colorado. The FIS represents the weighted average for all four weather percentiles.

The fire intensity scale map is derived at a 30-meter resolution. This scale of data was chosen to be consistent with the accuracy of the primary surface fuels dataset used in the assessment. While not appropriate for site specific analysis, it is appropriate for regional, county or local planning efforts.

	FIS Class	Acres	Percent
	Non-Burnable	53	3.9 %
	1 (Lowest Intensity)	0	0.0 %
	2 (Low)	8	0.6 %
	3 (Moderate)	18	1.3 %
	4 (High)	1,265	93.8 %
	5 (Highest Intensity)	5	0.4 %
	Total	1,349	100.0 %

Chandler Heights
Characteristic Fire Intensity Scale

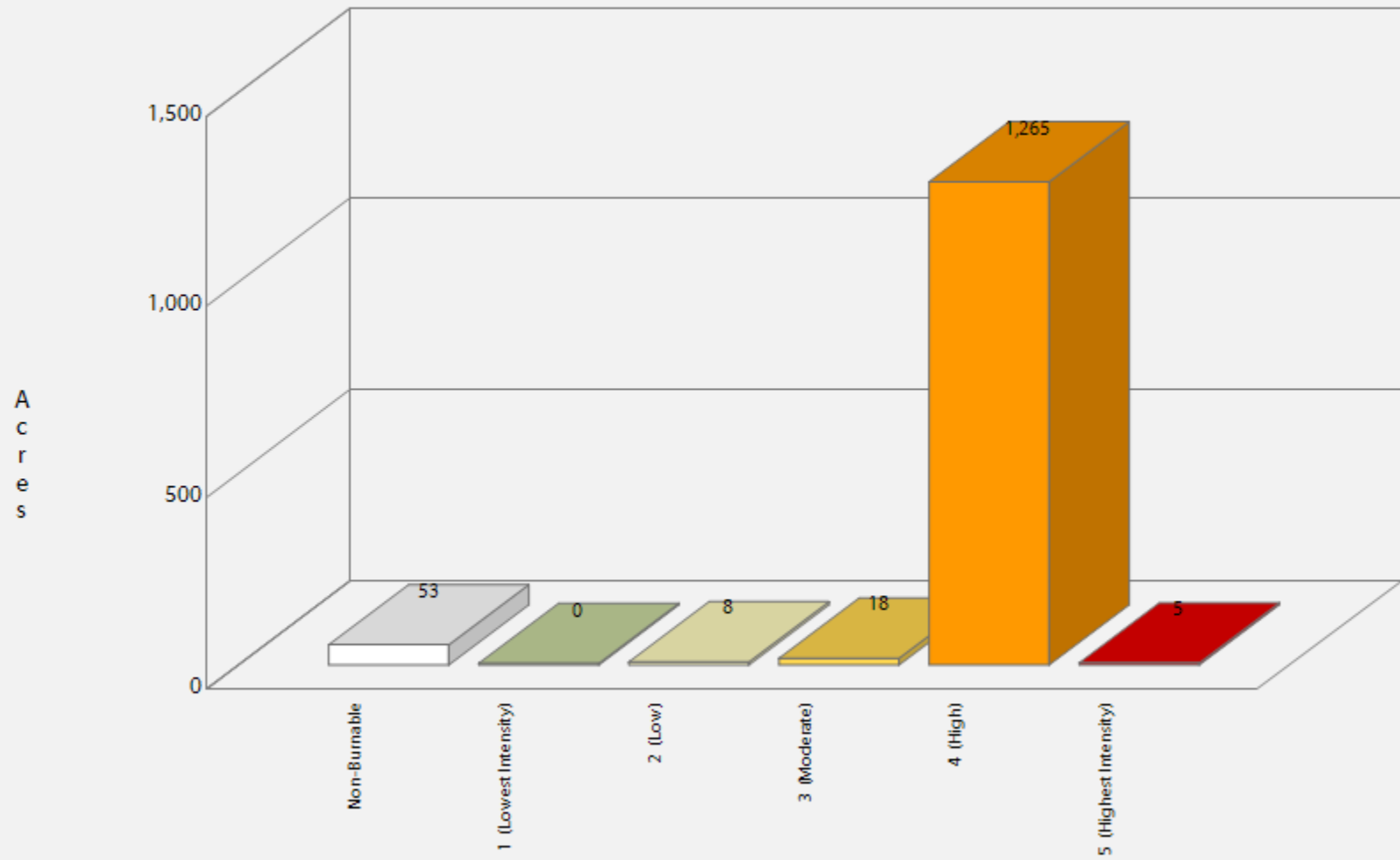

Fire Type – Extreme Weather

Fire Type – Extreme represents the potential fire type under the extreme percentile weather category. The extreme percentile weather category represents the average weather based on the top three percent fire weather days in the analysis period. It is not intended to represent a worst case scenario weather event. Accordingly, the potential fire type is based on fuel conditions, extreme percentile weather, and topography.

Canopy fires are very dangerous, destructive and difficult to control due to their increased fire intensity. From a planning perspective, it is important to identify where these conditions are likely to occur on the landscape so that special preparedness measure can be taken if necessary. Typically canopy fires occur in extreme weather conditions. The Fire Type – Extreme layer shows the footprint of where these areas are most likely to occur. However, it is important to note that canopy fires are not restricted to these areas. Under the right conditions, it can occur in other canopied areas.

There are two primary fire types – surface fire and canopy fire. Canopy fire can be further subdivided into passive canopy fire and active canopy fire. A short description of each of these is provided below.

Surface Fire

A fire that spreads through surface fuel without consuming any overlying canopy fuel. Surface fuels include grass, timber litter, shrub/brush, slash and other dead or live vegetation within about 6 feet of the ground.



Passive Canopy Fire

A type of crown fire in which the crowns of individual trees or small groups of trees burn, but solid flaming in the canopy cannot be maintained except for short periods (Scott & Reinhardt, 2001).





Active Canopy Fire

A crown fire in which the entire fuel complex (canopy) is involved in flame, but the crowning phase remains dependent on heat released from surface fuel for continued spread (Scott & Reinhardt, 2001).



The Fire Type - Extreme Weather map is derived at a 30-meter resolution. This scale of data was chosen to be consistent with the accuracy of the primary surface fuels dataset used in the assessment. While not appropriate for site specific analysis, it is appropriate for regional, county or local planning efforts.

Fire Type – Extreme Weather		Acres	Percent
	Surface Fire	1,256	96.9 %
	Passive Canopy Fire	37	2.8 %
	Active Canopy Fire	4	0.3 %
Total		1,296	100.0 %

Chandler Heights
Fire Type - Extreme

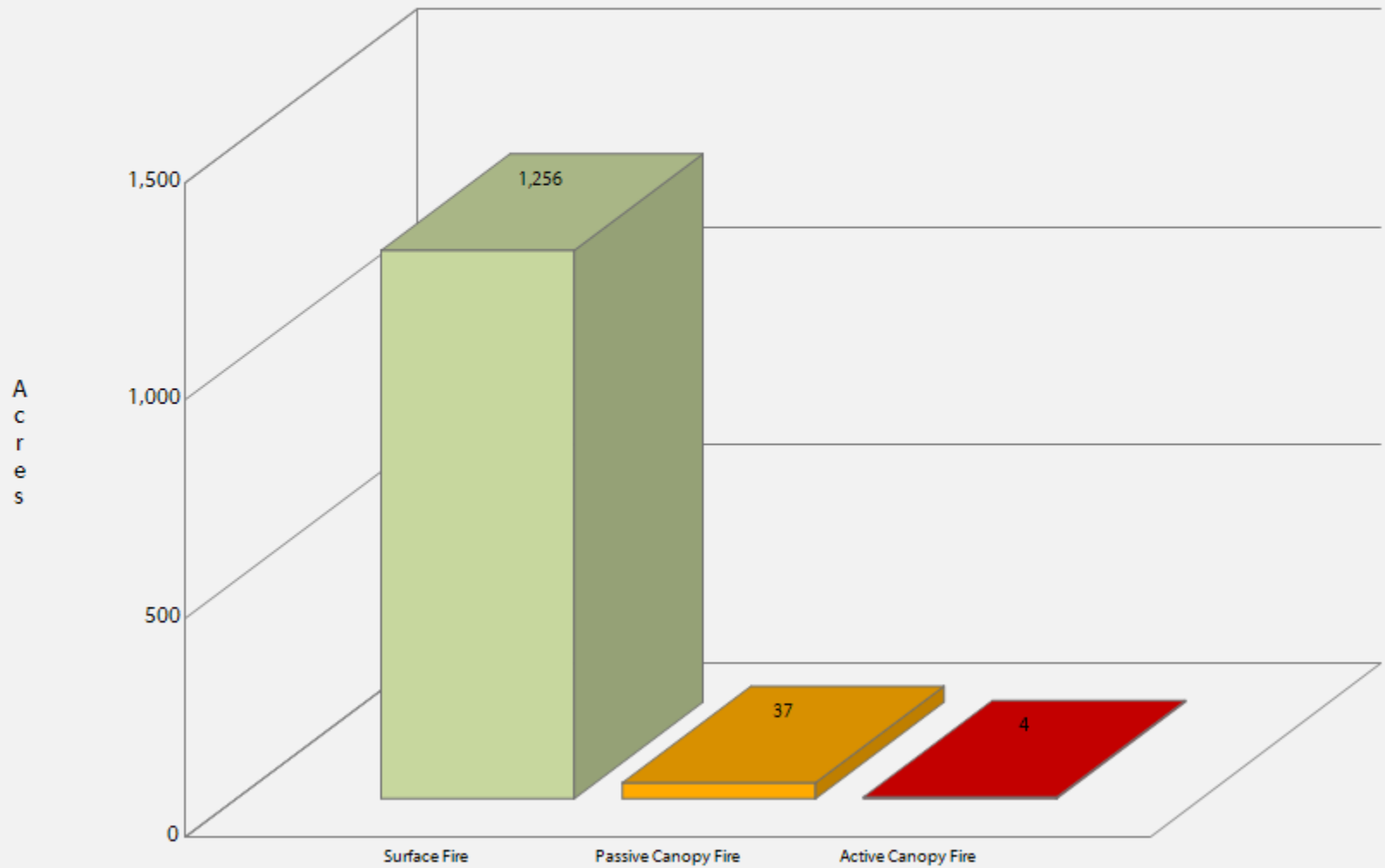

Surface Fuels

Description

Surface fuels, or fire behavior fuel models as they are technically referred to, contain the parameters required by the Rothermel (1972) surface fire spread model to compute surface fire behavior characteristics, including rate of spread, flame length, fireline intensity and other fire behavior metrics. As the name might suggest, surface fuels account only for surface fire potential. Canopy fire potential is computed through a separate but linked process. The Colorado WRA accounts for both surface and canopy fire potential in the fire behavior outputs. However, only surface fuels are shown in this report.



Unmanaged forest with dead and downed trees and branches



Slash on the ground indicates that forest management treatments have occurred in this area

Surface fuels typically are categorized into one of four primary fuel types based on the primary carrier of the surface fire: 1) grass, 2) shrub/brush, 3) timber litter, and 4) slash. Two standard fire behavior fuel model sets have been published. The Fire Behavior Prediction System 1982 Fuel Model Set (Anderson, 1982) contains 13 fuel models, and the Fire Behavior Prediction System 2005 Fuel Model Set (Scott & Burgan, 2005) contains 40 fuel models. The Colorado WRA uses fuel models from the 2005 Fuel Model Set.

The LANDFIRE Program Refresh 2008 version of data products was used to compile the Surface Fuels data for the West Wide Risk Assessment and the Colorado Wildfire Risk Assessment. This reflects data through 2008. Some modifications were completed to reflect recent disturbances, such as large wildfires and pine beetle infestations, prevalent in central Colorado over recent years. These updates reflect changes in the landscape that represent conditions through 2010. Information on the process used to compile the Colorado fuels dataset can be found in the West Wide Assessment Final Report cited on the Reference Page.

Surface Fuels	Description	FBPS Fuel Model Set	Acres	Percent
GR 1	Short, Sparse Dry Climate Grass (Dynamic)	2005	4	0.3 %
GR 2	Low Load, Dry Climate Grass (Dynamic)	2005	596	44.1 %
GR 3	Low Load, Very Coarse, Humid Climate Grass (Dynamic)	2005	0	0.0 %
GR 4	Moderate Load, Dry Climate Grass (Dynamic)	2005	0	0.0 %
GS 1	Low Load, Dry Climate Grass-Shrub (Dynamic)	2005	10	0.7 %
GS 2	Moderate Load, Dry Climate Grass-Shrub (Dynamic)	2005	631	46.8 %
SH 1	Moderate Load, Humid Climate Grass-Shrub (Dynamic)	2005	0	0.0 %
SH 2	Moderate Load, Dry Climate Shrub	2005	0	0.0 %
SH 3	Moderate Load, Humid Climate Timber-Shrub	2005	0	0.0 %
SH 5	High Load, Humid Climate Grass-Shrub	2005	3	0.2 %
SH 7	Very High Load, Dry Climate Shrub	2005	2	0.1 %
TU 1	Light Load, Dry Climate Timber-Grass-Shrub	2005	48	3.5 %
TU 2	Moderate Load, Humid Climate Timber-Shrub	2005	0	0.0 %
TU 5	High Load, Conifer Litter	2005	0	0.0 %
TL 1	Low Load, Compact Conifer Litter	2005	0	0.0 %
TL 2	Low Load, Broadleaf Litter	2005	0	0.0 %
TL 3	Moderate Load, Conifer Litter	2005	0	0.0 %
TL 4	Small Downed Logs	2005	0	0.0 %
TL 5	High Load, Conifer Litter	2005	0	0.0 %
TL 6	Moderate Load, Broadleaf Litter	2005	2	0.2 %
TL 7	Large Downed Logs, Heavy Load Forest Litter	2005	0	0.0 %
TL 8	Long-needle Litter	2005	0	0.0 %
TL 9	Very High Load, Broadleaf Litter	2005	0	0.0 %
SB 2	Moderate Load, Activity Fuel	2005	0	0.0 %
NB 1	Urban/Developed	2005	44	3.3 %
NB 2	Snow/Ice	2005	0	0.0 %
NB 3	Agricultural	2005	0	0.0 %
NB 8	Open Water	2005	0	0.0 %
NB 9	Bare Ground	2005	9	0.7 %
Total			1,349	100.0 %

Chandler Heights
Surface Fuels

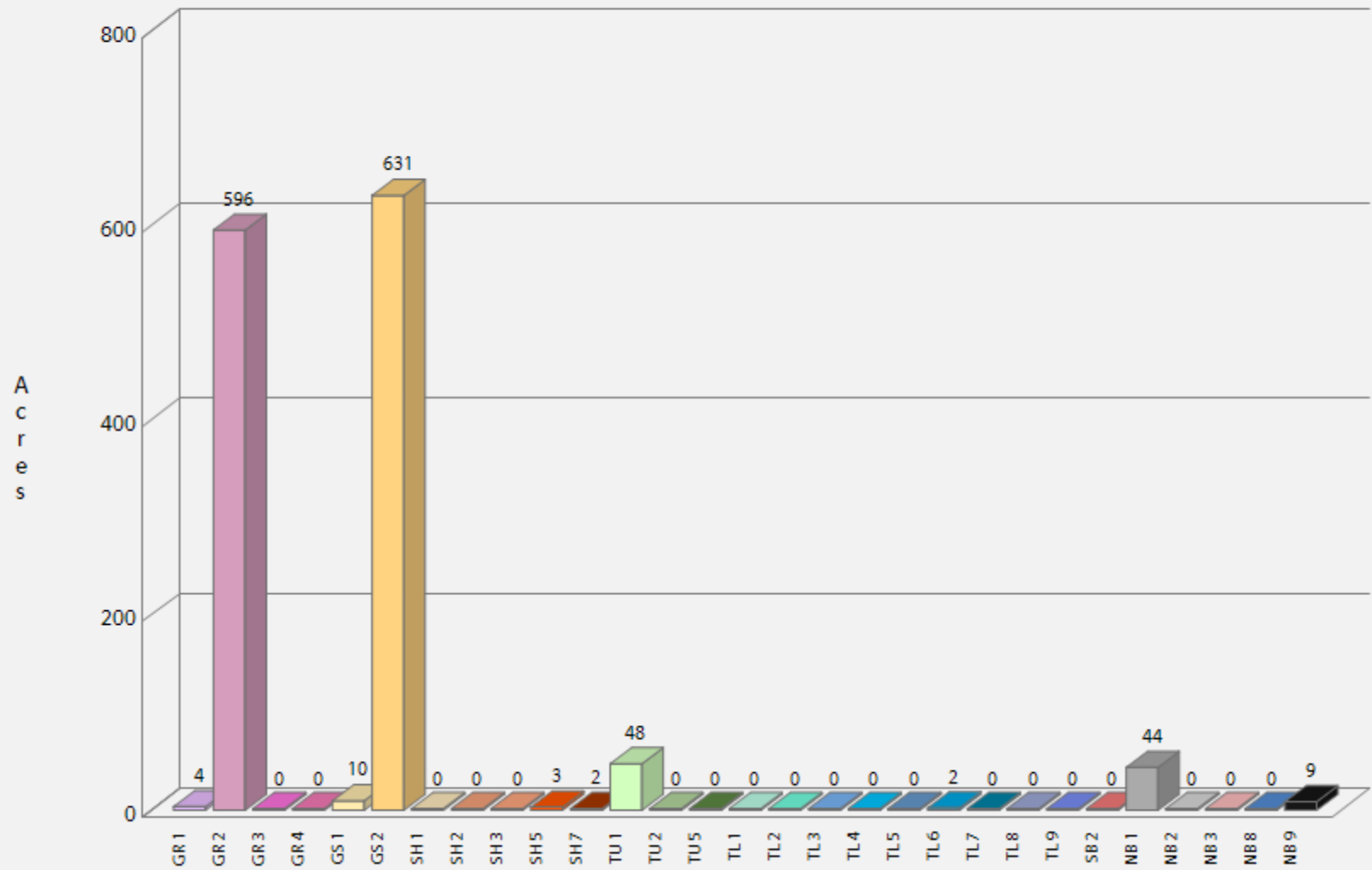

Vegetation

Description

The **Vegetation map describes the general vegetation and landcover types across the state of Colorado**. In the Colorado WRA, the Vegetation dataset is used to support the development of the Surface Fuels, Canopy Cover, Canopy Stand Height, Canopy Base Height, and Canopy Bulk Density datasets.

The LANDFIRE program Refresh version of data products (Existing Vegetation Type) was used to compile the Vegetation data for the West Wide Risk Assessment and the Colorado WRA. This reflects data current to 2008. Some modifications were completed to reflect recent disturbances such as large wildfires and pine beetle infestations prevalent in central Colorado over recent years. The LANDFIRE EVT data was classified to reflect general vegetation cover types for representation with CO-WRAP.



Oak shrublands are commonly found along dry foothills and lower mountain slopes, and are often situated above Piñon-juniper.



Piñon-juniper woodlands are common in southern and southwestern Colorado.



Douglas-fir understory in a ponderosa pine forest.



Grasslands occur both on Colorado's Eastern Plains and on the Western Slope.



Wildland fire threat increases in lodgepole pine as the dense forests grow old.

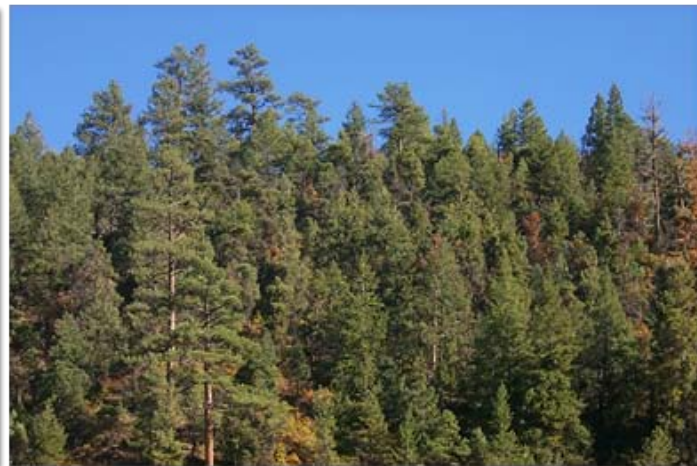

Overly dense ponderosa pine, a dominant species of the montane zone.

	Vegetation Class	Acres	Percent
	Grassland	589	45.8 %
	Shrubland	14	1.1 %
	Aspen	0	0.0 %
	Lodgepole Pine	0	0.0 %
	Ponderosa Pine	0	0.0 %
	Spruce-Fir	0	0.0 %
	Mixed Conifer	0	0.0 %
	Oak Shrubland	5	0.4 %
	Pinyon-Juniper	621	48.3 %
	Riparian	48	3.7 %
	Introduced Riparian	3	0.3 %
	Agriculture	0	0.0 %
	Open Water	0	0.0 %
	Urban & Community	6	0.5 %
	Total	1,286	100.0 %

Chandler Heights Vegetation

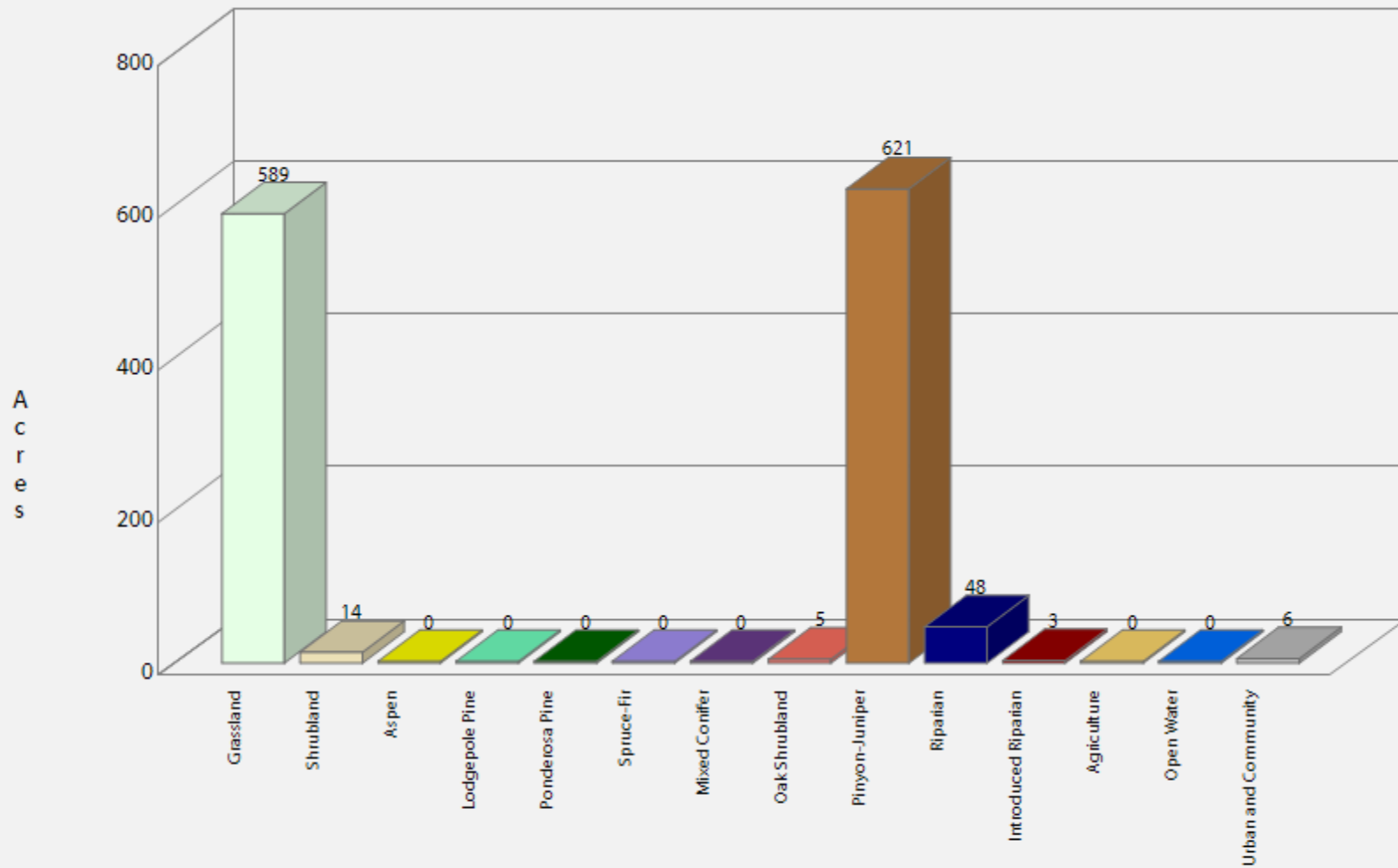

Drinking Water Importance Areas

Description

Drinking Water Importance Areas is the measure of quality and quantity of public surface drinking water categorized by watershed. This layer identifies an index of surface drinking water importance, reflecting a measure of water quality and quantity, characterized by Hydrologic Unit Code 12 (HUC 12) watersheds. The Hydrologic Unit system is a standardized watershed classification system developed by the USGS. Areas that are a source of drinking water are of critical importance and adverse effects from fire are a key concern.

The U.S. Forest Service Forests to Faucets (F2F) project is the primary source of the drinking water data set. This project used GIS modeling to develop an index of importance for supplying drinking water using HUC 12 watersheds as the spatial resolution. Watersheds are ranked from 1 to 100 reflecting relative level of importance, with 100 being the most important and 1 the least important.

Several criteria were used in the F2F project to derive the importance rating including water supply, flow analysis, and downstream drinking water demand. The final model of surface drinking water importance used in the F2F project combines the drinking water protection model, capturing the flow of water and water demand, with a model of mean annual water supply.



Virtually all of Colorado’s drinking water comes from snowmelt carried at some point by a river.

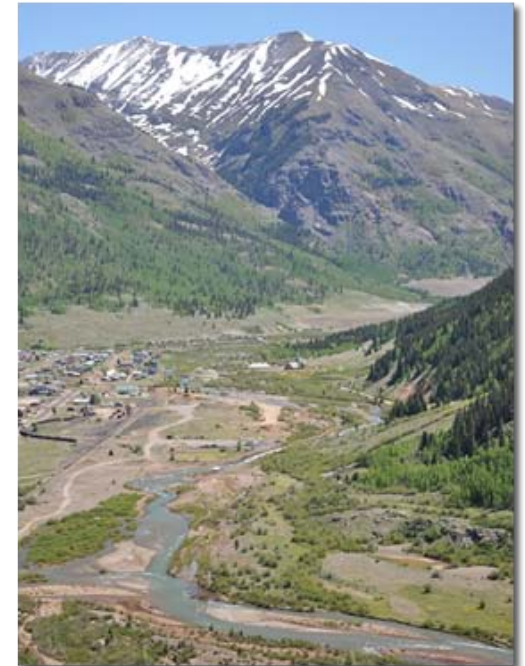

The headwaters of the Animas River begin near Silverton, CO at elevations greater than 12,000 feet.

The values generated by the drinking water protection model are simply multiplied by the results of the model of mean annual water supply to create the final surface drinking water importance index.

Water is critical to sustain life. Human water usage has further complicated nature’s already complex aquatic system. Plants, including trees, are essential to the proper functioning of water movement within the environment. Forests receive precipitation, utilize it for their sustenance and growth, and influence its storage and/or passage to other parts of the environment.

Four major river systems – the Platte, Colorado, Arkansas and Rio Grande – originate in the Colorado mountains and fully drain into one-third of the landmass of the lower 48 states. Mountain snows supply 75 percent of the water to these river systems.

Approximately 40 percent of the water comes from the highest 20 percent of the land, most of which lies in national forests. National forests yield large portions of the total water in these river systems. The potential is great for forests to positively and negatively influence the transport of water over such immense distances.

Drinking Water Class	Acres	Percent
1 - Lowest	0	0.0 %
2	0	0.0 %
3	0	0.0 %
4	0	0.0 %
5	0	0.0 %
6	0	0.0 %
7	0	0.0 %
8	870	64.5 %
9	479	35.5 %
10 - Highest	0	0.0 %
Total	1,349	100.0 %

Chandler Heights Drinking Water Importance Areas

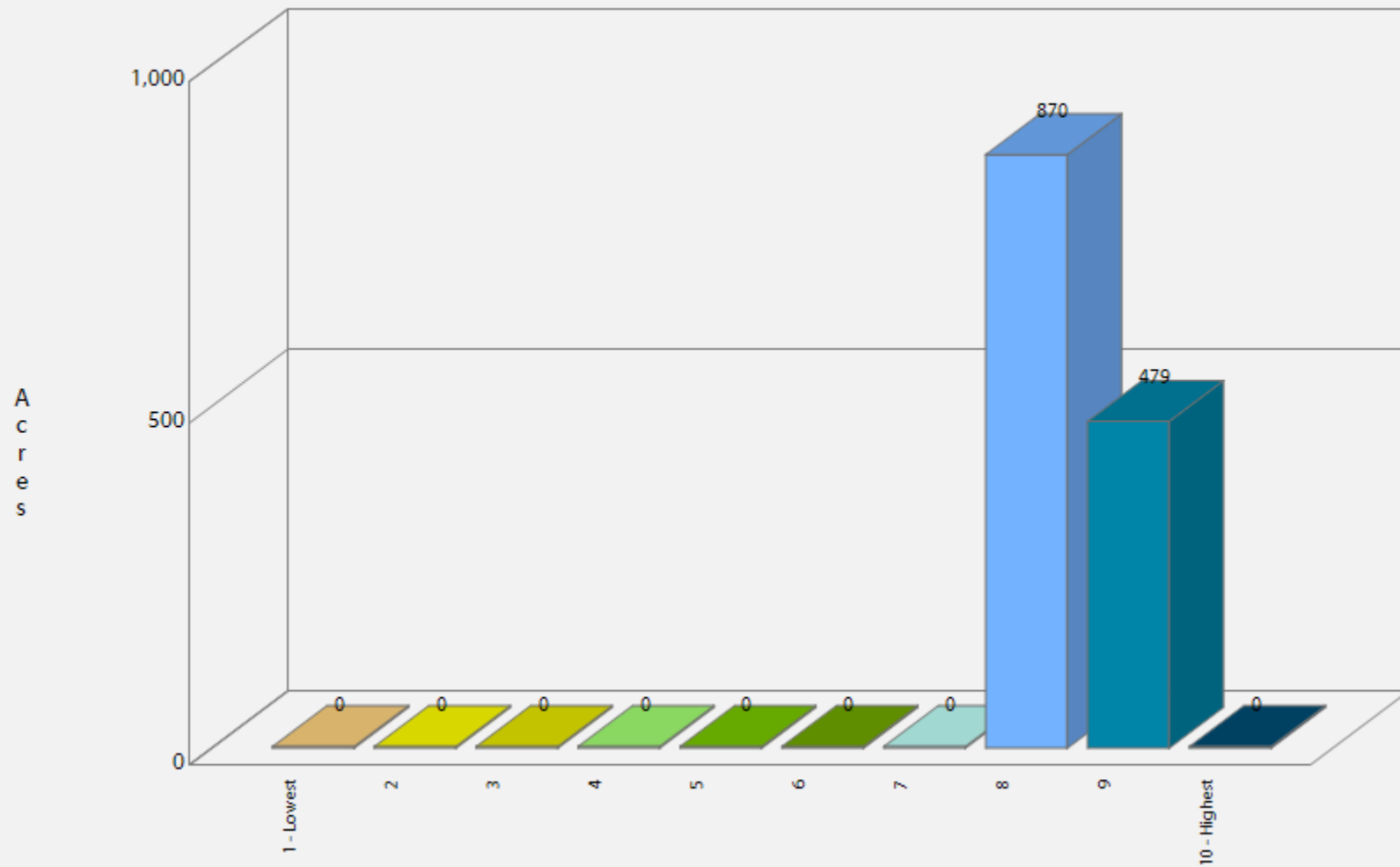

Drinking Water Risk Index

Description

Drinking Water Risk Index is a measure of the risk to DWIAs based on the potential negative impacts from wildfire.

In areas that experience low-severity burns, fire events can serve to eliminate competition, rejuvenate growth and improve watershed conditions. But in landscapes subjected to high, or even moderate-burn severity, the post-fire threats to public safety and natural resources can be extreme.

High-severity wildfires remove virtually all forest vegetation – from trees, shrubs and grasses down to discarded needles, decomposed roots and other elements of ground cover or duff that protect forest soils. A severe wildfire also can cause certain types of soil to become hydrophobic by forming a waxy, water-repellent layer that keeps water from penetrating the soil, dramatically amplifying the rate of runoff.

The loss of critical surface vegetation leaves forested slopes extremely vulnerable to large-scale soil erosion and flooding during subsequent storm events. In turn, these threats can impact the health, safety and integrity of communities and natural resources downstream. The likelihood that such a post-fire event will occur in Colorado is increased by the prevalence of highly erodible soils in several parts of the state, and weather patterns that frequently bring heavy rains on the heels of fire season.

In the aftermath of the 2002 fire season, the Colorado Department of Health estimated that 26 municipal water storage facilities were shut down due to fire and post-fire impacts.

The potential for severe soil erosion is a consequence of wildfire because as a fire burns, it destroys plant material and the litter layer. Shrubs, forbs, grasses, trees and the litter layer disperse water during severe rainstorms. Plant roots stabilize the soil, and stems and leaves slow the water to give it time to percolate into the soil profile. Fire can destroy this soil protection.

The range of values is from -1 to -9, with -1 representing the least negative impact and -9 representing the most negative impact.

Class	Acres	Percent
-1 (Least Negative Impact)	0	0.0 %
-2	1	0.0 %
-3	3	0.2 %
-4	311	23.2 %
-5	560	41.8 %
-6	440	32.8 %
-7	26	1.9 %
-8	0	0.0 %
-9 (Most Negative Impact)	0	0.0 %
Total	1,340	100.0 %

Chandler Heights Drinking Water Risk Index

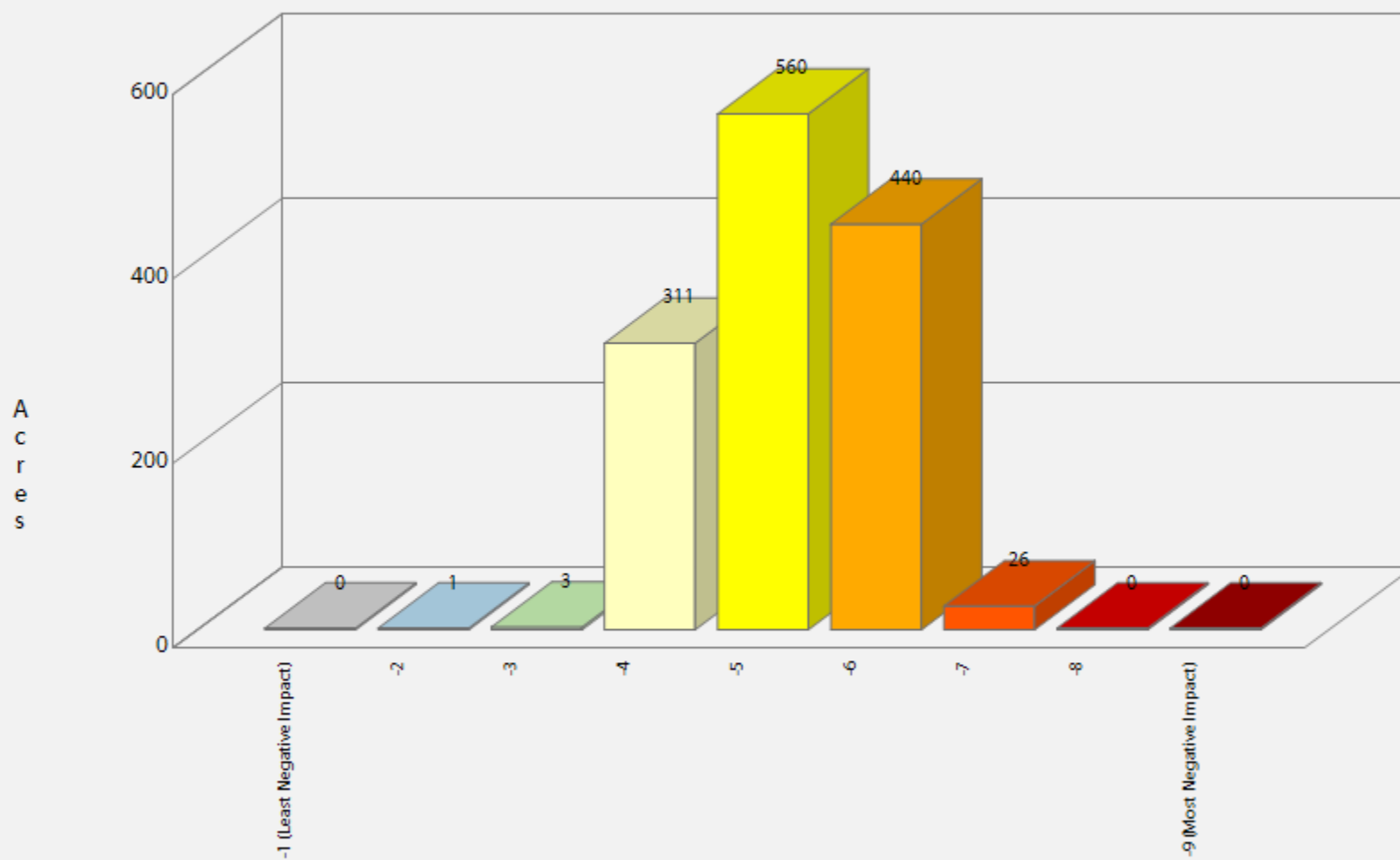

Riparian Assets

Description

Riparian Assets are forested riparian areas characterized by functions of water quantity and quality, and ecology. This layer identifies riparian areas that are important as a suite of ecosystem services, including both terrestrial and aquatic habitat, water quality, water quantity, and other ecological functions. Riparian areas are considered an especially important element of the landscape in the west. Accordingly, riparian assets are distinguished from other forest assets so they can be evaluated separately.

The process for defining these riparian areas involved identifying the riparian footprint and then assigning a rating based upon two important riparian functions – water quantity and quality, and ecological significance. A scientific model was developed by the West Wide Risk Assessment technical team with in-kind support



from CAL FIRE state representatives. Several input datasets were used in the model including the National Hydrography Dataset and the National Wetland Inventory.

The National Hydrography Data Set (NHD) was used to represent hydrology. A subset of streams and water bodies, which represents perennial, intermittent, and wetlands, was created. The NHD water bodies data set was used to determine the location of lakes, ponds, swamps, and marshes (wetlands).

To model water quality and quantity, erosion potential (K-factor) and annual average precipitation was used as key variables. The Riparian Assets data is an index of class values that range from 1 to 3 representing increasing importance of the riparian area as well as sensitivity to fire-related impacts on the suite of ecosystem services.

Riparian Assets Class	Acres	Percent
Least Sensitive to Wildland Fires	42	35.7 %
	68	57.7 %
Most Sensitive to Wildland Fires	8	6.6 %
Total	118	100.0 %

Chandler Heights
Riparian Assets

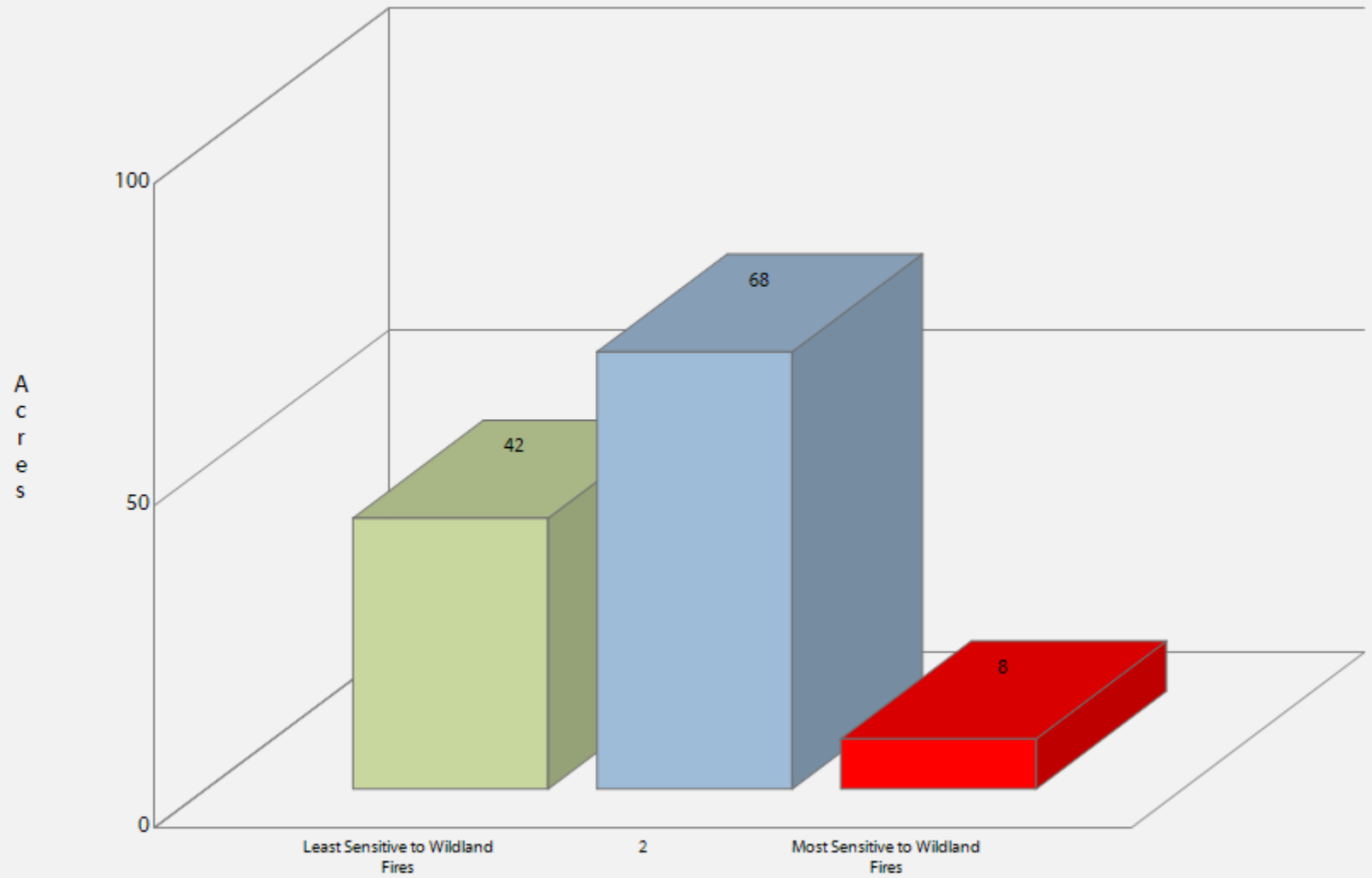

Riparian Assets Risk Index

Description

Riparian Assets Risk Index is a measure of the risk to riparian areas based on the potential negative impacts from wildfire. This layer identifies those riparian areas with the greatest potential for adverse effects from wildfire.

The range of values is from -1 to -9, with -1 representing the least negative impact and -9 representing the most negative impact.

The risk index has been calculated by combining the Riparian Assets data with a measure of fire intensity using a Response Function approach. Those areas with the highest negative impact (-9) represent areas with high potential fire intensity and high

importance for ecosystem services. Those areas with the lowest negative impact (-1) represent those areas with low potential fire intensity and a low importance for ecosystem services.

This risk output is intended to supplement the Drinking Water Risk Index by identifying wildfire risk within the more detailed riparian areas.

Riparian Assets Risk Class	Acres	Percent
-1 (Least Negative Impact)	0	0.0 %
-2	2	6.7 %
-3	13	38.0 %
-4	18	55.3 %
-5	0	0.0 %
-6	0	0.0 %
-7	0	0.0 %
-8	0	0.0 %
-9 (Most Negative Impact)	0	0.0 %
Total	33	100.0 %

Chandler Heights
Riparian Asset Risk Index

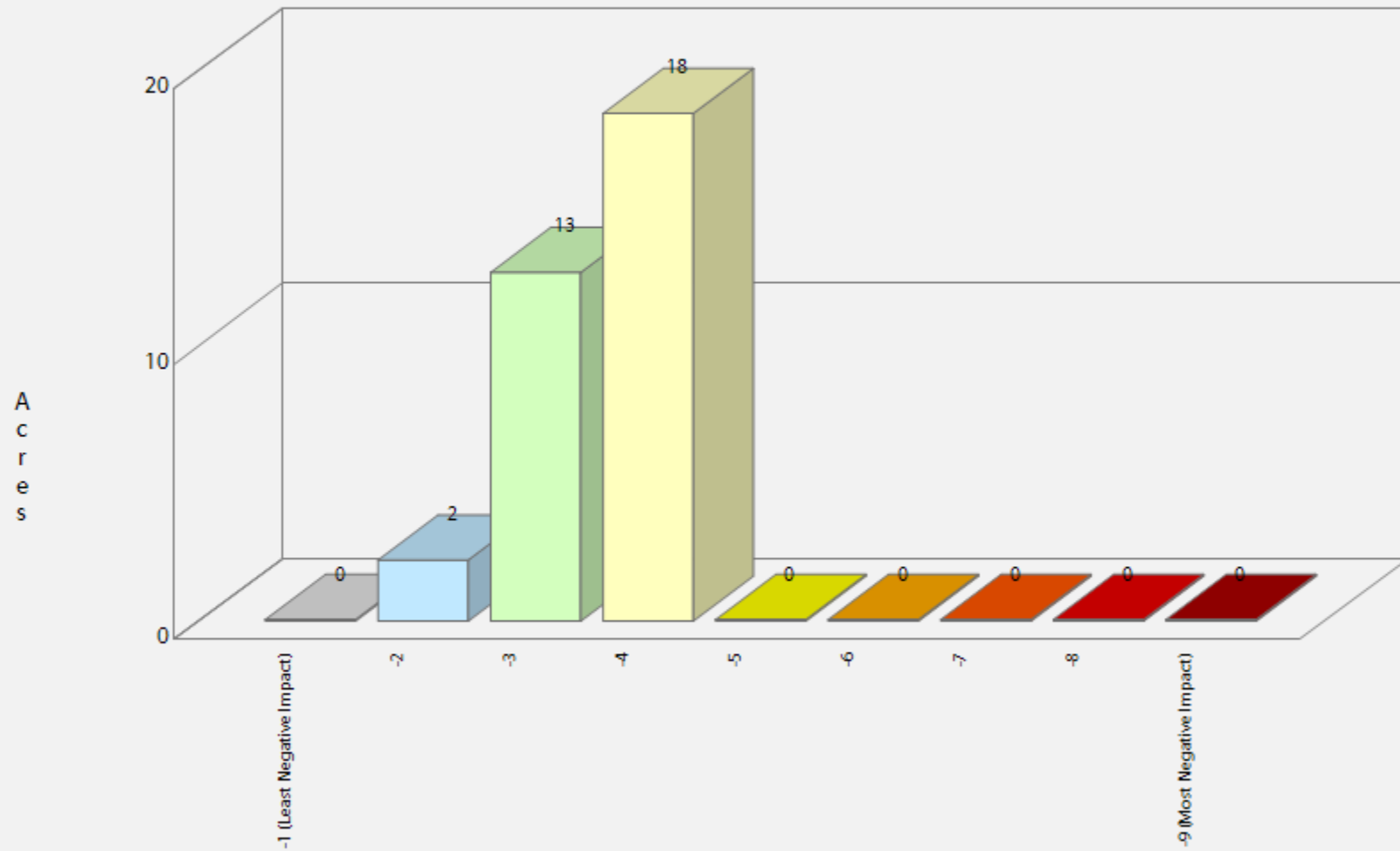

Forest Assets

Description

Forest Assets are forested areas categorized by height, cover, and susceptibility/response to fire. This layer identifies forested land categorized by height, cover and susceptibility or response to fire. Using these characteristics allows for the prioritization of landscapes reflecting forest assets that would be most adversely affected by fire. The rating of importance or value of the forest assets is relative to each state’s interpretation of those characteristics considered most important for their landscapes.



Canopy cover from LANDFIRE was re-classified into two categories, open or sparse and closed. Areas classified as open or sparse have a canopy cover less than 60%. Areas classified as closed have a canopy cover greater than 60%.

Canopy height from LANDFIRE was re-classified into two categories, 0-10 meters and greater than 10 meters.

Response to fire was developed from the LANDFIRE existing vegetation type (EVT) dataset. There are over 1,000 existing vegetation types in the project area. Using a crosswalk defined by project ecologists, a classification of susceptibility and response to fire was defined and documented by fire ecologists into the three fire response classes.

These three classes are sensitive, resilient and adaptive.

- **Sensitive** = These are tree species that are intolerant or sensitive to damage from fire with low intensity.
- **Resilient** = These are tree species that have characteristics that help the tree resist damage from fire and whose adult stages can survive low intensity fires.
- **Adaptive** = These are tree species adapted with the ability to regenerate following fire by sprouting or serotinous cones

Forest Assets Class		Acres	Percent
	Adaptive	44	96.1 %
	Resilient	2	3.9 %
	Sensitive	0	0.0 %
Total		46	100.0 %

Forest Assets Risk Index

Description

Forest Assets Risk Index is a measure of the risk to forested areas based on the potential negative impacts from wildfire. This layer identifies those forested areas with the greatest potential for adverse effects from wildfire.

The range of values is from -1 to -9, with -1 representing the least negative impact and -9 representing the most negative impact.

The risk index has been calculated by combining the Forest Assets data with a measure of fire intensity using a Response Function approach. Those areas with the highest negative impact (-9) represent areas with high potential fire intensity and low resilience or adaptability to fire. Those areas with the lowest negative impact (-1) represent those areas with low potential fire intensity and high resilience or adaptability to fire.

This risk output is intended to provide an overall forest index for potential impact from wildfire. This can be applied to consider aesthetic values, ecosystem services, or economic values of forested lands.

Forest Assets Risk Class	Acres	Percent
-1 (Least Negative Impact)	0	0.0 %
-2	2	5.3 %
-3	6	14.0 %
-4	37	80.7 %
-5	0	0.0 %
-6	0	0.0 %
-7	0	0.0 %
-8	0	0.0 %
-9 (Most Negative Impact)	0	0.0 %
Total	46	100.0 %

Chandler Heights
Forest Asset Risk Index

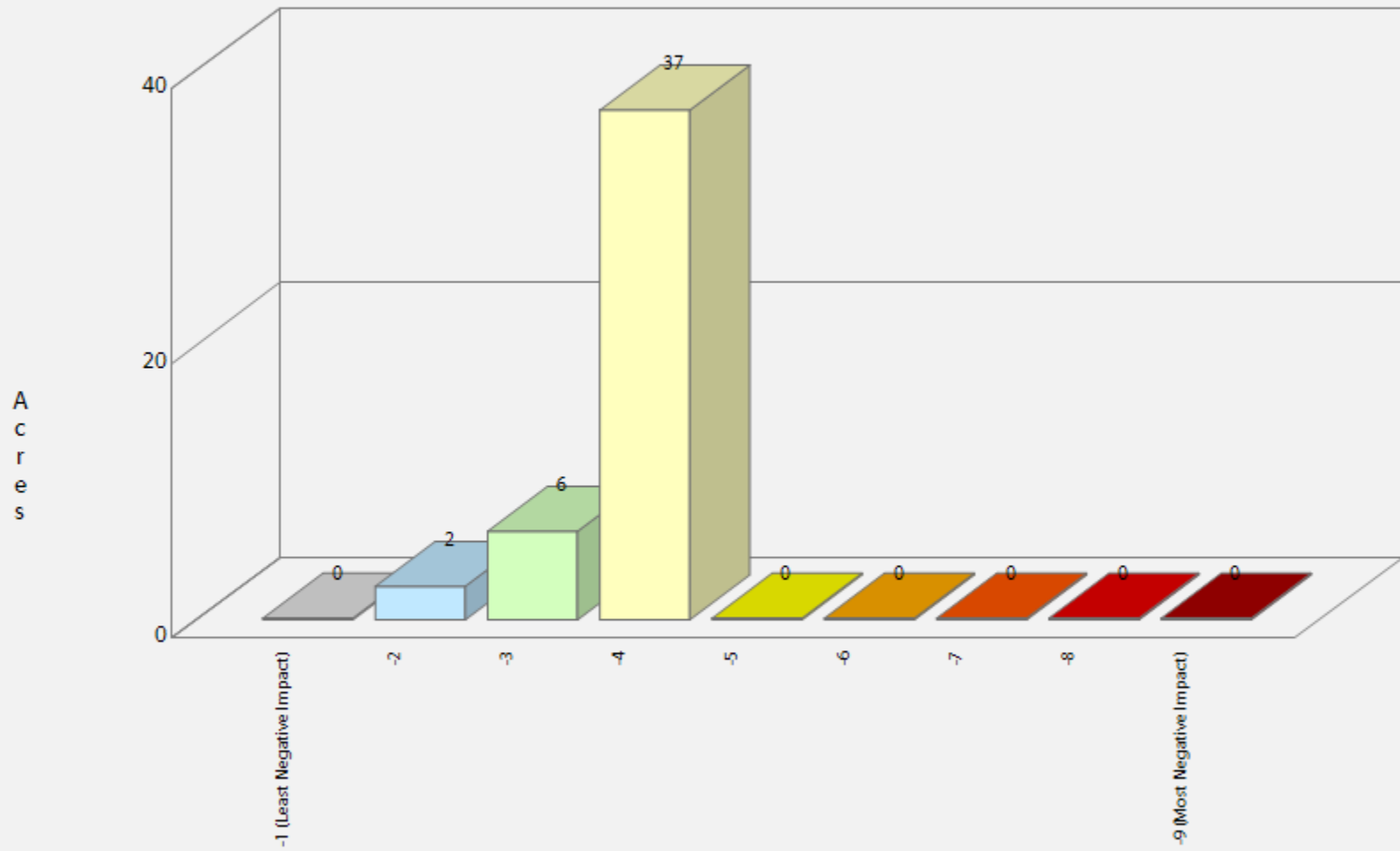

References

- Anderson, H. E. (1982). Aids to determining fuel models for estimating fire behavior. USDA For. Serv. Gen. Tech. Rep. INT-122.
- Colorado State Forest Service (2012). Colorado Wildfire Risk Assessment 2012 Final Report. A final report developed by CSFS and DTS (Fort Collins, CO) documenting the technical methods and specifications for the Colorado WRA project.
- National Wildfire Coordinating Group (NWCG). (2008). Glossary of Wildland Fire Terminology. Publication Management System document PMS-205.
- National Wildfire Coordinating Group (2004). Fireline Handbook. NWCG Handbook 3. PMS 410-1. NFES 0065. National Interagency Fire Center. Boise, Idaho 83705.
- Scott, J. H., & Burgan, R. E. (2005). Standard Fire Behavior Fuel Models: A Comprehensive Set for Use with Rothermel's Surface Fire Spread Model. Ft. Collins, CO, Rocky Mountain Research Station: USDA Forest Service, Gen. Tech. Rpt. RMRS-GTR-153.
- Scott, J. H., & Reinhardt, E. D. (2001). Assessing the Crown Fire Potential by Linking Models of Surface and Crown Fire Behavior. Ft. Collins, CO, Rocky Mountain Research Station: USDA Forest Service, Research Paper RMRS-RP-29.
- West Wide Risk Assessment, Western Forestry Leadership Coalition (2012). West Wide Risk Assessment Final Report. Salem, OR. A final report developed by the WWA Technical Team documenting the methods and specifications of the WWA project.





QUICK GUIDE SERIES

FIRE 2012-1

Protecting Your Home from Wildfire: Creating Wildfire-Defensible Zones

Formerly CSU Extension Factsheet 6.302

If your home is located in the natural vegetation of Colorado's grasslands, shrublands, foothills or mountains, you live in the **wildland-urban interface (WUI)** and are inherently at risk from a wildfire. The WUI is any area where structures and other human developments meet or intermingle with wildland vegetative fuels. In many vegetation types, it is not a matter of *if* a wildfire will impact your home, but *when*.

Wildfires are a natural part of Colorado's varied forest ecosystems. Many rural communities are located in areas historically prone to frequent natural wildfires. Living in the wildland requires more self-reliance than living in urban areas. It may take longer for a fire engine to reach your area, and a small fire department can easily become overwhelmed during an escalating wildfire. Planning ahead and taking actions to reduce fire hazards can increase your safety and help protect your property. As more people choose to live in areas prone to wildfire, additional homes and lives are potentially threatened every year. Firefighters always do their best to protect rural residents, but ultimately, **it is YOUR responsibility to protect your life, family, animals and property from wildfire.**

The information contained in this document is for use by individual landowners to help reduce wildfire risk on their property. In order to effectively protect subdivisions and communities, all

landowners must work together to reduce fire hazards within and adjacent to communities. This includes treating individual home sites and common areas within communities, and creating fuelbreaks within and adjoining the community where feasible. This document will focus on actions individual landowners can take to reduce wildfire hazards on their property. For additional information on broader community protection, go to www.csfs.colostate.edu.



Figure 2: Colorado's grasslands, shrublands, foothills and mountains all have areas in the wildland-urban interface where human development meets wildland vegetative fuels. Photo: CSFS

In this guide, you'll read about steps you can take to protect your property from wildfire. These steps focus on beginning work closest to your house and moving outward. Also, remember that keeping your home safe is not a one-time effort – it requires ongoing maintenance. It may be necessary to perform some actions, such as removing pine needles from gutters and mowing grasses and weeds several times a year, while other actions may only need to be addressed once a year. While



Figure 1: Firefighters will do their best to protect homes, but ultimately it is the homeowner's responsibility to plan ahead and take actions to reduce fire hazards around structures. Photo: National Interagency Fire Center

This quick guide was produced by the Colorado State Forest Service to promote knowledge transfer.

October 2012
www.csfs.colostate.edu

you may not be able to accomplish ALL of the actions described in this document to prepare your home for wildfire, each completed activity will increase the safety of your home, and possibly your family, during a wildfire.

(Note: These guidelines are adapted for ponderosa pine, Douglas-fir and mixed-conifer ecosystems below 9,500 feet. See page 9 for guidelines adapted to other forest ecosystems.)

This guide primarily will help design your defensible space. **Defensible space** is the natural and landscaped area around a home or other structure that has been modified to reduce fire hazard. Defensible space gives your home a fighting chance against an approaching wildfire. Creating defensible space also reduces the chance of a structure fire spreading to the surrounding forest and other homes.

Three factors determine wildfire behavior: **fuels, weather and topography**. We cannot alter weather or topography, so we must concentrate on altering fuels. Fuels include vegetation, such as trees, brush and grass; near homes, fuels also include

such things as propane tanks, wood piles, sheds and even homes themselves. Some plant species are more flammable than others, and the flammability of vegetative fuels changes depending on the season, recent weather events, and other factors such as drought. Fuel continuity and density also play an important role in wildfire.

Wildfire often creates its own weather conditions. Hot rising air and associated winds can carry embers and other burning materials into the atmosphere for long distances, where they can ignite vegetation and structures up to several miles away. Embers have caused the loss of many homes during wildfires.

As you think about protecting your home and property from wildfire, consider how you can manage fuels on your property to prevent fire from spreading to your home and other structures.

For more information on wildfire behavior, please see [FireWise Construction: Site Design and Building Materials](http://www.csfs.colostate.edu) at www.csfs.colostate.edu.

Fuel Arrangement and Types

When fuels are abundant, a fire can be uncontrollable and destructive. But when fuels are scarce, a fire cannot build momentum and intensity, which makes it much easier to control and is more likely to be beneficial to the land.

The more dense and continuous the fuels, the bigger the threat they pose to your home. The measure of fuel hazard refers to its continuity, both horizontal and vertical. Horizontal continuity refers to fuels across the ground, while vertical continuity refers to fuels extending from the ground up into the crowns of trees and shrubs. Fuels with a high degree of both vertical and horizontal continuity are the most hazardous, particularly when they occur on slopes. Mitigation of wildfire hazards focuses on breaking up the continuity of horizontal and vertical fuels.

Heavier fuels, such as brush and trees, produce a more intense fire than light fuels, such as grass. However, grass-fueled fires travel much faster than heavy-fueled fires. Some heavier surface fuels, such as logs and wood chips, are potentially hazardous heavy fuels and also should be addressed.



Figure 3: Burning embers can be carried long distances by wind. Embers ignite structures when they land in gaps, crevices and other combustible places around the home. Photo: CSFS

Remember...

- **Reducing fuels around a home will increase the chances for survival in a wildfire, but there is no guarantee.**
- **This quick guide provides minimum guidelines. The more fuels you remove, the greater the chance your home will survive.**
- **Working with your neighbors and community will increase the effectiveness of your home's defensible space.**

Vertical/Ladder Fuels

Ladder fuels are defined as smaller trees and brush that provide vertical continuity, which allows a fire to burn from the ground level up into the branches and crowns of larger trees. Lower branches on large trees also can act as ladder fuels. These fuels are potentially very hazardous, but are easy to mitigate. The hazards from ladder fuels near homes are especially important to address. Prune all tree branches from ground level up to a height of 10 feet above ground or up to $\frac{1}{3}$ the height of the tree, whichever is less. Do not prune further up because it could jeopardize the health of the tree. Shrubs should be pruned based on specifications recommended for the species. Dead branches should be removed whenever possible.

Surface Fuels

Logs/Branches/Slash/Wood Chips

Naturally occurring woody material on the ground and debris from cutting down trees (also known as slash) may increase the intensity of fires. Increased fire intensity makes a fire harder to control and increases the likelihood of surface fires transitioning to crown fires. Dispose of any heavy accumulation of logs, branches and slash by chipping, hauling to a disposal site or piling for burning later. Always contact your county sheriff's office or local fire department first for information about burning slash piles. Another alternative is to lop and scatter slash by cutting it into very small pieces and distributing it widely over the ground. If chipping logs and/or slash, it's essential to avoid creating continuous areas of wood chips on the ground. Break up the layer of wood chips by adding nonflammable material, or allow for wide gaps (at least 3 feet) between chip accumulations. Also, avoid heavy accumulation of slash by spreading it closer to the ground to speed decomposition. If desired, two or three small, widely spaced brush piles may be left for wildlife habitat. Locate these well away from your home (NOT in Zones 1 or 2; see page 5-8 for zone descriptions).

Pine Needles/Duff Layers

Due to decades of fire suppression, decomposing layers of pine needles, twigs and other organic debris—called duff—is deeper under many large trees today than it would have been a century ago. This is especially true in ponderosa pine forests where frequent and naturally occurring fires have been absent. These large trees often are lost when fires occur, because flames burning in the duff layer can pre-heat live vegetation and ignite the trees, or the tree's roots can be damaged from the intense heat of the smoldering duff, killing the tree. It is important to rake needle or duff layers deeper than 2 inches at least 3 feet away from the base of large trees. This should be done annually, and the additional duff also should be removed from the area.

Grasses

Grasses are perhaps the most pervasive and abundant surface fuel in Colorado. Mow grasses and weeds as often as needed throughout the growing season to keep them shorter than 6 inches. This applies to irrigated lawns and wild or native grasses. This is critical in the fall, when grasses dry out, and in the spring, after the snow is gone but before plants green-up.

Be especially careful when mowing in areas with rocks. Mower blades can hit rocks and create sparks, causing fires in dry grass. Consider mowing only on days with high humidity or after recent moisture to reduce the risk of starting an unwanted fire.

When mowing around trees, be sure to avoid damaging the root system and tree trunk by using a higher blade setting on the mower and trimming grass that grows against the trunk only by hand.

Crown Fuels

An intense fire burning in surface fuels can transition into the upper portion of the tree canopies and become a crown fire. Crown fires are dangerous because they are very intense and can burn large areas. Crown fire hazard can be reduced by thinning trees to decrease crown fuels, reducing surface fuels under the remaining trees, and eliminating vertical fuel continuity from the surface into the crowns. Specific recommendations are provided in the Defensible Space Management Zones, pages 5-8.



Figure 4: Ladder fuels are shrubs and low branches that allow a wildfire to climb from the ground into the tree canopy. Photo: CSFS



Figure 5: Surface fuels include logs, branches, wood chips, pine needles, duff and grasses. Photo: CSFS



Figure 6: Tree canopies offer fuel for intense crown fires. Photo: Paul Mintier

The Home Ignition Zone



Figure 7: Addressing both components of the Home Ignition Zone will provide the best protection for your home. Credit: CSFS

Two factors have emerged as the primary determinants of a home's ability to survive a wildfire – the quality of the defensible space and a structure's ignitability. Together, these two factors create a concept called the **Home Ignition Zone (HIZ)**, which includes the structure and the space immediately surrounding the structure. To protect a home from wildfire, the primary goal is to reduce or eliminate fuels and ignition sources within the HIZ.

Structural Ignitability

The ideal time to address home ignition risk is when the structure is in the design phase. However, you can still take steps to reduce ignitability to an existing home.

The **roof** has a significant impact on a structure's ignitability because of its extensive surface area. When your roof needs significant repairs or replacement, use only fire-resistant roofing materials. Also, check with your county building department – some counties now have restrictions against using wood shingles for roof replacement or require specific classifications of roofing material. Wood and shake-shingle roofs are discouraged because they are highly flammable, and are prohibited in some areas of the state. Asphalt shingles, metal sheets and shingles, tile, clay tile, concrete and slate shingles are all recommended roofing materials.

The extension of the roof beyond the exterior structure wall is the eave. This architectural feature is particularly prone to ignition. As fire approaches the building, the exterior wall deflects hot air and gasses up into the eave. If the exterior wall isn't ignition-resistant, this effect is amplified.

Most **decks** are highly combustible. Their shape traps hot gasses, making them the ultimate heat traps. Conventional wooden decks are so combustible that when a wildfire approaches, the deck often ignites before the fire reaches the house.

The **exterior walls** of a home or other structure are affected most by radiant heat from the fire and, if defensible space is not adequate, by direct contact with flames from the fire.

Windows are one of the weakest parts of a building with regard to wildfire. They usually fail before the building ignites, providing a direct path for flames and airborne embers to reach the building's interior.

Burning embers are produced when trees and structures are consumed by wildfire. These embers sometimes can travel more than a mile. Flammable horizontal or nearly horizontal surfaces, such as wooden decks or shake-shingle roofs, are especially at risk for ignition from burning embers. Since airborne embers have caused the loss of many homes in the WUI, addressing structural ignitability is critical, even if the area surrounding a home is not conducive to fire spread.

This guide provides only basic information about structural ignitability. For more information on fire-resistant building designs and materials, refer to the CSFS *FireWise Construction: Site Design and Building Materials* publication at www.csfs.colostate.edu.



Figure 8: (above) Wood shingle roofs are highly flammable and not recommended. Photo: CSFS

Figure 9: (above right) Class A roofing materials including tile, clay, concrete, slate and asphalt shingles are fire-resistant options. Photo: CSFS



Figure 10: Decks, exterior walls and windows are important areas to examine when addressing structure ignitability. Photo: CSFS

Defensible Space

Defensible space is the area around a home or other structure that has been modified to reduce fire hazard. In this area, natural and manmade fuels are treated, cleared or reduced to slow the spread of wildfire. Creating defensible space also works in the reverse, and reduces the chance of a structure fire spreading to neighboring homes or the surrounding forest. Defensible space gives your home a fighting chance against an approaching wildfire.

Creating an effective defensible space involves a series of management zones in which different treatment techniques are used. Develop these zones around each building on your property, including detached garages, storage buildings, barns and other structures.

The actual design and development of your defensible space depends on several factors: size and shape of building(s), construction materials, slope of the ground, surrounding topography, and sizes and types of vegetation on your property. You may want to request additional guidance from your local Colorado State Forest Service forester, fire department or a consulting forester as you plan a defensible space for your property.

Defensible space provides another important advantage during a fire: increased firefighter safety. Firefighters are trained to protect structures only when the situation is relatively safe for them to do so. They use a process called “structural triage” to determine if it is safe to defend a home from an approaching wildfire. The presence or absence of defensible space around a structure is a significant determining factor used in the structural triage process, as defensible space gives firefighters an opportunity to do their job more safely. In turn, this increases their ability to protect your home.

If firefighters are unable to directly protect your home during a wildfire, having an effective defensible space will still increase your home’s chance of survival. It is important to remember that with wildfire, there are no guarantees. Creating a proper defensible space does not mean that your home is guaranteed to survive a wildfire, but it does significantly improve the odds.

Defensible Space Management Zones

Three zones need to be addressed when creating defensible space:

Zone 1 is the area nearest the home and other structures. This zone requires maximum hazard reduction.

Zone 2 is a transitional area of fuels reduction between Zones 1 and 3.

Zone 3 is the area farthest from the home. It extends from the edge of Zone 2 to your property boundaries.



Figure 11: Homesite before defensible space. Photo: CSFS



Figure 12: Homesite after creating a defensible space. Photo: CSFS

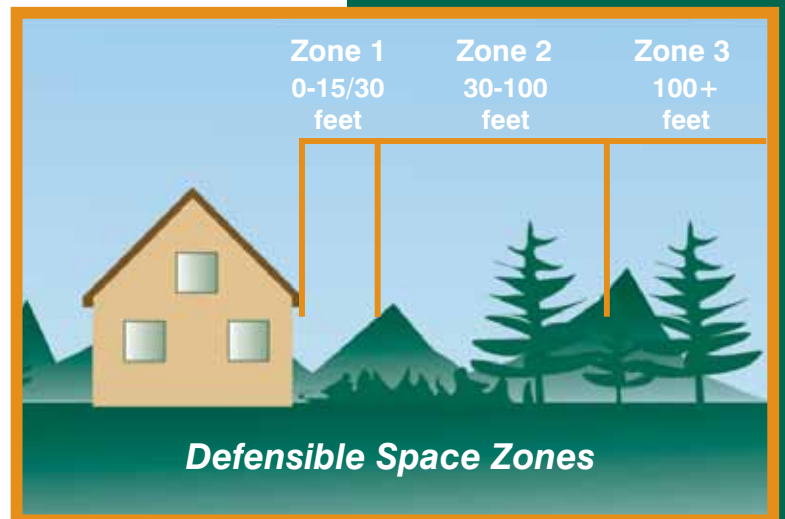

Figure 13: Defensible space management zones. Credit: CSFS

Zone 1

The width of Zone 1 extends a minimum distance of 15-30 feet outward from a structure, depending on property size. Most flammable vegetation is removed in this zone, with the possible exception of a few low-growing shrubs or fire-resistant plants. Avoid landscaping with common ground junipers, which are highly flammable.

Increasing the width of Zone 1 will increase the structure's survivability. This distance should be increased 5 feet or more in areas downhill from a structure. The distance should be measured from the outside edge of the home's eaves and any attached structures, such as decks. Several specific treatments are recommended within this zone:

- Install nonflammable ground cover and plant nothing within the first 5 feet of the house and deck. This critical step will help prevent flames from coming into direct contact with the structure. This is particularly important if a building is sided with wood, logs or other flammable materials. Decorative rock creates an attractive, easily maintained, nonflammable ground cover.
- If a structure has noncombustible siding (i.e., stucco, synthetic stucco, concrete, stone or brick), widely spaced foundation plantings of low-growing shrubs or other fire-resistant plant materials are acceptable. However, do not plant directly under windows or next to foundation vents, and be sure areas of continuous grass are not adjacent to plantings. Information on fire-resistant plants is available on the CSFS website at www.csfs.colostate.edu.
- Prune and maintain any plants in Zone 1 to prevent excessive growth. Also, remove all dead branches, stems and leaves within and below the plant.
- Irrigate grass and other vegetation during the growing season. Also, keep wild grasses mowed to a height of 6 inches or less.
- Do not store firewood or other combustible materials anywhere in this zone. Keep firewood at least 30 feet away from structures, and uphill if possible.
- Enclose or screen decks with 1/8-inch or smaller metal mesh screening (1/16-inch mesh is preferable). Do not use areas under decks for storage.
- Ideally, remove all trees from Zone 1 to reduce fire hazards. The more trees you remove, the safer your home will be.
- If you do keep any trees in this zone, consider them part of the structure and extend the distance of the entire defensible space accordingly.
- Remove any branches that overhang or touch the roof, and remove all fuels within 10 feet of the chimney.
- Remove all pine needles and other debris from the roof, deck and gutters.
- Rake pine needles and other organic debris at least 10 feet away from all decks and structures.
- Remove slash, wood chips and other woody debris from Zone 1.

Zone 2

Zone 2 is an area of fuels reduction designed to diminish the intensity of a fire approaching your home. The width of Zone 2 depends on the slope of the ground where the structure is built. Typically, the defensible space in Zone 2 should extend at least 100 feet from all structures. If this distance stretches beyond your property lines, try to work with the adjoining property owners to complete an appropriate defensible space.



Figure 14: *This homeowner worked hard to create a defensible space around the home. Notice that all fuel has been removed within the first 5 feet of the home, which survived the Waldo Canyon Fire in the summer of 2012. Photo: Christina Randall, Colorado Springs Fire Department*



Figure 15: *Clearing pine needles and other debris from the roof and gutters is an easy task that should be done at least once a year. Photo: CSFS*



Figure 16: *Enclosing decks with metal screens can prevent embers from igniting a house. Photo: Marilyn Brown, La Plata County*

The following actions help reduce continuous fuels surrounding a structure, while enhancing home safety and the aesthetics of the property. They also will provide a safer environment for firefighters to protect your home.

Tree Thinning and Pruning

- Remove stressed, diseased, dead or dying trees and shrubs. This reduces the amount of vegetation available to burn, and makes the forest healthier.
- Remove enough trees and large shrubs to create at least 10 feet between crowns. Crown separation is measured from the outermost branch of one tree to the nearest branch on the next tree. On steep slopes, increase the distance between tree crowns even more.
- Remove all ladder fuels from under remaining trees. Prune tree branches off the trunk to a height of 10 feet from the ground or $\frac{1}{3}$ the height of the tree, whichever is less.
- If your driveway extends more than 100 feet from your home, thin out trees within a 30 foot buffer along both sides of your driveway, all the way to the main access road. Again, thin all trees to create 10-foot spacing between tree crowns.
- Small groups of two or three trees may be left in some areas of Zone 2, but leave a minimum of 30 feet between the crowns of these clumps and surrounding trees.
- Because Zone 2 forms an aesthetic buffer and provides a transition between zones, it is necessary to blend the requirements for Zones 1 and 3. For example, if you have a tree in Zone 2 with branches extending into Zone 1, the tree can be retained if there is proper crown spacing.
- Limit the number of dead trees (snags) to one or two per acre. Be sure snags cannot fall onto the house, power lines, roads or driveways.
- As in Zone 1, the more trees and shrubs removed, the more likely your house will survive a wildfire.



Figure 17: In Zone 2, make sure there is at least a 10-foot spacing between tree crowns. Credit: CSFS

Shrub Thinning/Pruning and Surface Fuels

- Isolated shrubs may be retained in Zone 2, provided they are not growing under trees.
- Keep shrubs at least 10 feet away from the edge of tree branches. This will prevent the shrubs from becoming ladder fuels.
- Minimum spacing recommendations between clumps of shrubs is $2\frac{1}{2}$ times the mature height of the vegetation. The maximum diameter of the clumps themselves should be twice the mature height of the vegetation. As with tree-crown spacing, all measurements are made from the edge of vegetation crowns.
- Example – For shrubs 6 feet high, spacing between shrub clumps should be 15 feet or more (measured from the edge of the crowns of vegetation clumps). The diameter of these shrub clumps should not exceed 12 feet.
- Periodically prune and maintain shrubs to prevent excessive growth, and remove dead stems from shrubs annually. Common ground junipers should be removed whenever possible because they are highly flammable and tend to hold a layer of duff beneath them.
- Mow or trim wild grasses to a maximum height of 6 inches. This is especially critical in the fall, when grasses dry out.
- Avoid accumulations of surface fuels, such as logs, branches, slash and wood chips greater than 4 inches deep.



Figure 18: Pruning trees will help prevent a wildfire from climbing from the ground to the tree crowns. Credit: CSFS

Firewood

- Stack firewood uphill from or on the same elevation as any structures, and at least 30 feet away.
- Clear all flammable vegetation within 10 feet of woodpiles.
- Do not stack wood against your home or on/under your deck, even in the winter. Many homes have burned as a result of a woodpile that ignited first.

Propane Tanks and Natural Gas Meters

- Locate propane tanks and natural gas meters at least 30 feet from any structures, preferably on the same elevation as the house.
- The tank should not be located below your house because if it ignites, the fire would tend to burn uphill. Conversely, if the tank or meter is located above your house and it develops a leak, gas will flow downhill into your home.
- Clear all flammable vegetation within 10 feet of all tanks and meters.
- Do not visibly screen propane tanks or natural gas meters with shrubs, vegetation or flammable fencing. Instead, install 5 feet of nonflammable ground cover around the tank or meter.



Figure 19: Keep firewood, propane tanks and natural gas meters at least 30 feet away from structures. Photo: CSFS



Figure 20: This ponderosa pine forest has been thinned, which will not only help reduce the wildfire hazard, but also increase tree health and vigor. Photo: CSFS

Zone 3

Zone 3 has no specified width. It should provide a gradual transition from Zone 2 to areas farther from the home that have other forest management objectives. Your local Colorado State Forest Service forester can help you with this zone.

This zone provides an opportunity for you to improve the health of the forest through proper management. With an assortment of stewardship options, you can proactively manage your forest to reduce wildfire intensity, protect water quality, improve wildlife habitat, boost the health and growth rate of your trees, and increase tree survivability during a wildfire.

In addition, properly managed forests can provide income, help protect trees against insects and diseases, and even increase the value of your property. Typical forest management objectives for areas surrounding home sites or subdivisions provide optimum recreational opportunities; enhance aesthetics; improve tree health and vigor; provide barriers against wind, noise, dust and visual intrusions; support production of firewood, fence posts and other forest commodities; or cultivate Christmas trees or trees for transplanting.

Consider the following when deciding forest management objectives in Zone 3:

- The healthiest forest is one that includes trees of multiple ages, sizes and species, and where adequate growing room is maintained over time.
- Remember to consider the hazards associated with ladder fuels. A forest with a higher canopy reduces the chance of a surface fire climbing into the tops of the trees, and might be a priority if this zone has steep slopes.
- A greater number of snags – two or three per acre, standing or fallen – can be retained in Zone 3 to provide wildlife habitat. These trees should have a minimum diameter of 8 inches. Make sure that snags pose no threat to power lines or firefighter access roads.
- While tree pruning generally is not necessary in Zone 3, it may be a good idea from the standpoint of personal safety to prune trees along trails and firefighter access roads. Or, if you prefer the aesthetics of a well-manicured forest, you might prune the entire area. In any case, pruning helps reduce ladder fuels within tree stands, thus reducing the risk of crown fire.
- Mowing grasses is not necessary in Zone 3.
- Any approved method of slash treatment is acceptable, including piling and burning, chipping or lop-and-scatter.

Other Recommendations

Windthrow

In Colorado, some tree species, including lodgepole pine, Engelmann spruce and Douglas-fir, are especially susceptible to damage and uprooting by high winds or windthrow. If you see evidence of this problem in or near your home, consider making adjustments to the defensible space guidelines. It is highly recommended that you contact a professional forester to help design your defensible space, especially if you have windthrow concerns.

Water Supply

If possible, make sure that an on-site water source is readily available for firefighters to use, or that other water sources are close by. Lakes, ponds, swimming pools and hot tubs are all possible options. If there are no nearby water sources, consider installing a well-marked dry hydrant or cistern. If your primary water source operates on electricity, be sure to plan for a secondary water source. During wildfires, structures often are cut off from electricity. For more information on how to improve the accessibility of your water source, contact your local fire department.

Recommendations for Specific Forest Types

The above recommendations refer primarily to ponderosa pine, Douglas-fir and mixed-conifer ecosystems. For other forest types, please refer to the additional recommendations below:

Aspen

Tree spacing and ladder fuel guidelines do not apply to mature stands of aspen trees. Generally, no thinning is recommended in aspen forests, regardless of tree size, because the thin bark is easily damaged, making the tree easily susceptible to fungal infections. However, in older stands, numerous dead trees may be on the ground and require removal. Conifer trees often start growing in older aspen stands. A buildup of these trees eventually will increase the fire hazard of the stand, so you should remove the young conifers. Brush also can increase the fire hazard and should be thinned to reduce flammability.

Lodgepole Pine

Lodgepole pine management in the WUI is much different than that for lodgepole pine forests located away from homes, communities and other developments. Normally, it is best to develop fuels management and wildfire mitigation strategies that are informed and guided by the ecology of the tree species. This is not the case with lodgepole pine.

Older lodgepole pine stands generally do not respond well to selective thinning, but instead respond better to the removal of all trees over a defined area to allow healthy forest regeneration. Selectively thinning lodgepole can open the stand to severe windthrow and stem breakage. However, if your home is located within a lodgepole pine forest, you may prefer selective thinning to the removal of all standing trees.

To ensure a positive response to thinning throughout the life of a lodgepole pine stand, trees must be thinned early in their lives – no later than 20 to 30 years after germination. Thinning lodgepole pine forests to achieve low densities can best be



Figure 21: During high winds, these lodgepole pine trees fell onto the house. Lodgepole pine is highly susceptible to windthrow. Photo: CSFS



Figure 22: Mature aspen stands can contain many young conifers, dead trees and other organic debris. This can become a fire hazard. Photo: CSFS



Figure 23: A young lodgepole pine stand. Thinning lodgepole pines early on in their lives will help reduce the wildfire hazard in the future. Photo: CSFS

The defensible space guidelines in this quick guide are predominantly for ponderosa pine and mixed-conifer forests. These guidelines will vary with other forest types.

accomplished by beginning when trees are small saplings, and maintaining those densities through time as the trees mature.

Thinning older stands of lodgepole pine to the extent recommended for defensible space may take several thinning operations spaced over a decade or more. When thinning mature stands of lodgepole pine, do not remove more than 30 percent of the trees in each thinning operation. Extensive thinning of dense, pole-sized and larger lodgepole pine often results in windthrow of the remaining trees. Focus on removing trees that are obviously lower in height or suppressed in the forest canopy. Leaving the tallest trees will make the remaining trees less susceptible to windthrow.

Another option is leaving clumps of 30-50 trees. Clumps are less susceptible to windthrow than solitary trees. Allow a minimum of 30-50 feet between tree crowns on the clump perimeter and any adjacent trees or clumps of trees. Wildfire tends to travel in the crowns of lodgepole pine. By separating clumps of trees with large spaces between crowns, the fire is less likely to sustain a crown fire.

Piñon-Juniper

Many piñon-juniper (PJ) forests are composed of continuous fuel that is highly flammable. Fire in PJ forests tend to burn intensely in the crowns of trees. Try to create a mosaic pattern when you thin these trees, with a mixture of individual trees and clumps of three to five trees. The size of each clump will depend on the size, health and location of the trees. The minimum spacing between individual trees should be 10 feet between tree crowns, with increasing space for larger trees, clumps, and stands on steeper slopes.

Tree pruning for defensible space is not as critical in PJ forests as in pine or fir forests. Instead, it is more important to space the trees so that it is difficult for the fire to move from one tree clump to the next. Trees should only be pruned to remove dead branches or branches that are touching the ground. However, if desired, live branches can be pruned to a height of 3 feet above the ground. Removing shrubs that are growing beneath PJ canopies is recommended to reduce the overall fuel load that is available to a fire.

It is NOT recommended to prune live branches or remove PJ trees between April and October, when the piñon ips beetle is active in western Colorado. Any thinning activity that creates the flow of sap in the summer months can attract these beetles to healthy trees on your property. However, it is acceptable to remove dead trees and dead branches during the summer months.

For more information, please refer to the CSFS [Piñon-Juniper Management Quick Guide](http://www.csfs.colostate.edu) at www.csfs.colostate.edu.

Gambel Oak

Maintaining Gambel oak forests that remain resistant to the spread of wildfire can be a challenge because of their vigorous growing habits. Gambel oak trees grow in clumps or groves, and the stems in each clump originate from the same root system. Most reproduction occurs through vegetative sprouts from this deep, extensive root system. You may need to treat Gambel oak near your home every five to seven years. Sprouts also should be mowed at least once every year in Zones 1 and 2. Herbicides can be used to supplement mowing efforts for controlling regrowth.

For more information, please refer to the CSFS [Gambel Oak Management](http://www.csfs.colostate.edu) publication at www.csfs.colostate.edu.

Note: This publication does not address high-elevation spruce-fir forests. For information on this forest type, please contact your local CSFS district office.



Figure 24: Piñon-juniper forests are often composed of continuous fuels. Creating clumps of trees with large spaces in between clumps will break up the continuity. Photo: CSFS



Figure 25: Gambel oak needs to be treated in a defensible space at least every 5-7 years because of its vigorous growing habits. Photo: CSFS

Maintaining Your Defensible Space

Your home is located in a dynamic environment that is always changing. Trees, grasses and shrubs continue to grow, die or are damaged, and drop their leaves and needles each season. Just like your home, the defensible space around it requires regular, ongoing maintenance to be effective. Use the following checklists to build and maintain your defensible space.

Defensible Space: Initial Projects

- Properly thin and prune trees and shrubs within Zones 1 and 2.
- Dispose of slash from tree/shrub thinning.
- Screen attic, roof, eaves and foundation vents, and periodically check them to ensure that they are in good condition.
- Screen or wall-in stilt foundations and decks; screens should be 1/8-inch or smaller metal mesh (1/16-inch mesh is best).
- Post signs at the end of the driveway with your last name and house number that are noncombustible, reflective and easily visible to emergency responders.
- Make sure that the driveway is wide enough for fire trucks to enter and exit, and that trees and branches are adequately cleared for access by fire and emergency equipment. Contact your local fire department or check the CSFS website for information specific to access.
- Take pictures of your completed defensible space for comparison of forest growth over time.



Figure 26: Keeping the forest properly thinned and pruned in a defensible space will reduce the chances of a home burning during a wildfire. Photo: CSFS

Defensible Space Tasks: Annual Requirements

- Clear roof, deck and gutters of pine needles and other debris. *
- Mow grass and weeds to a height of 6 inches or less. *
- Rake all pine needles and other flammable debris away from the foundation of your home and deck. *
- Remove trash and debris accumulations from the defensible space.*
- Check fire extinguishers to ensure that they have not expired and are in good working condition.
- Check chimney screens to make sure they are in place and in good condition.
- Remove branches that overhang the roof and chimney.
- Check regrowth of trees and shrubs by reviewing photos of your original defensible space; properly thin and prune trees and shrubs within Zones 1 and 2.
- Dispose of slash from tree/shrub thinning. *

*Address more than once per year, as needed.

Be Prepared

- Complete a checklist of fire safety needs inside your home (these should be available at your local fire department). Examples include having an evacuation plan and maintaining smoke detectors and fire extinguishers.
- Develop your fire evacuation plan and practice family fire drills. Ensure that all family members are aware of and understand escape routes, meeting points and other emergency details.
- Contact your county sheriff's office and ensure that your home telephone number and any other important phone numbers appear in the county's Reverse 911 or other emergency notification database.
- Prepare a "grab and go" disaster supply kit that will last at least three days, containing your family's and pets' necessary items, such as cash, water, clothing, food, first aid and prescription medicines.
- Ensure that an outdoor water supply is available. If it is safe to do so, make a hose and nozzle available for responding firefighters. The hose should be long enough to reach all parts of the house.



Figure 27: Sharing information and working with your neighbors and community will give your home and surrounding areas a better chance of surviving a wildfire. Photo: CSFS

Preparing your home and property from wildfire is a necessity if you live in the wildland-urban interface. It is important to adequately modify the fuels in your home ignition zone. Remember, every task you complete around your home and property will make your home more defensible during a wildfire.

Always remember that creating and maintaining an effective defensible space in the home ignition zone is not a one-time endeavor – it requires an ongoing, long-term commitment.

If you have questions, please contact your local CSFS district office. Contact information can be found at www.csfs.colostate.edu.

List of Additional Resources

- The Colorado State Forest Service, <http://www.csfs.colostate.edu>
- CSFS wildfire-related publications, <http://csfs.colostate.edu/pages/wf-publications.html>
- Community Wildfire Protection Planning, <http://csfs.colostate.edu/pages/community-wf-protection-planning.html>
- Colorado's "Are You FireWise?" information, <http://csfs.colostate.edu/pages/wf-protection.html>
- National Fire Protection Association's Firewise Communities USA, <http://www.firewise.org>
- Fire Adapted Communities, <http://fireadapted.org/>
- Ready, Set, Go!, <http://wildlandfirersg.org/>



Figure 28: *This house has a high risk of burning during an approaching wildfire. Modifying the fuels around a home is critical to reduce the risk of losing structures during a wildfire. Photo: CSFS*



Figure 29: *This house survived the Fourmile Canyon Fire in 2010. Photo: CSFS*



Figure 30: *Firefighters were able to save this house during the 2012 Weber Fire because the homeowners had a good defensible space. Photo: Dan Bender, La Plata County*

**Colorado
State
FOREST
SERVICE**

www.csfs.colostate.edu

This quick guide was produced by the Colorado State Forest Service (CSFS). CSFS programs are available to all without discrimination. No endorsement of products or services is intended, nor is criticism implied of products not mentioned.

ALERT FREMONT

Register your wireless phone number now to be part of the database when 911 Emergency Notification calls are made to your neighborhood.

Go to www.fremontco.com

Open the "Alert Fremont (9-1-1 Wireless Phone Alerts)" box on the Home Page.

Click on the '[Emergency Wireless Registration](#)' link displayed to register your cell or VOIP phone.

The E 9-1-1 Authority Board recently upgraded the **Alert Fremont** Emergency Notification (911 alert calls) services provided through Twenty First Century Communications. This upgrade will improve and expand the use of Emergency Notification services across the county. One significant benefit of **Alert Fremont** is the ability of the residents of Fremont County to sign up their wireless (cell) phone numbers and Voice Over Internet Protocol (VOIP) phone numbers to the 9-1-1 data base. That means if an **Alert Fremont** message was launched in your neighborhood or county wide, the message would be delivered to your wireless/VOIP phone. There is no additional charge to sign up your phone numbers to the 9-1-1 data base. The security of your wireless numbers in this data base is a priority. Your security concerns and many other frequently asked questions are answered by visiting "[Alert Fremont's FAQ's](#)" page.

If you have previously registered your wireless numbers, please check to ensure data (location) is correct. To do this click on "Emergency Wireless Registration" and enter the e-mail you used to register, then click on "Forgot your password?" to receive a password. After receipt of your password, you can then log on and verify information. If your registered location is incorrect (defaults to Fremont Count Admin Bldg) you may have to manually move the marker to your correct location. 9-1-1 emergency dispatchers in Cañon City and Florence along with officials from the various public safety agencies in the county will have immediate internet access to launch emergency messages countywide, in specific neighborhoods, or to targeted groups of emergency providers.

The Fremont County Emergency Telephone Authority was established in 1989 to provide and administer emergency (911) telephone service to Fremont County. The board of directors is comprised of five members; Fremont County Commissioner Ed Norden; Calvin Sunderman, the representative of special districts and public agencies; Tom McCormick, the representative of the Florence PSAP (Public Safety Answering Point); Jim Cox, the representative of the Canon City PSAP; and Randy Leshner the at-large member elected by the other four.

**Chandler Heights
CWPP Triage**

Structure #¹	Lat	Lon	Field Rating	Notes & Traige Codes
1	38.384815°	-105.175411°	N	A-B-C-D-I
2	38.384593°	-105.175838°	N	A-B-C-D-H-I
3	38.381771°	-105.175868°	N	A-B-C-D-H-I
4	38.381378°	-105.174106°	Y	Safety Zone
5	38.379483°	-105.175251°	N	A-B-C-D-H-I
6	38.377554°	-105.174103°	Y	
7	38.377487°	-105.176233°	Y	
8	38.376629°	-105.175372°	N	A-B-C-D-I-J
9	38.376069°	-105.177118°	N	A-B-C-D-H-I
10	38.373792°	-105.179240°	N	A-B-C-D-I
11	38.371863°	-105.182608°	Y	
12	38.369989°	-105.186089°	N	A-B-C-D-H-I
13	38.373650°	-105.189208°	N	A-B-C-D-H-I
14	38.374381°	-105.189450°	N	A-B-C-D-H-I
15	38.374850°	-105.190604°	N	A-B-C-D-I
16	38.377167°	-105.188928°	N	A-B-D-H-I
17	38.379789°	-105.188973°	Y	
18	38.383534°	-105.184387°	N	A-B-H-J
¹ See Appendix B for structure locations				